

G9 Drum Workstation



Model	G9
Document	Owner's Manual
Version	1.0
Release Date	2020-08-17



Manufacturer

GEWA music GmbH
Delsnitzer Straße 58
08626 Adorf

GERMANY



Please read this Owner's Manual carefully before operating the device and take note of the safety information! Keep this document available for immediate reference.



Download the complete user's manual on [gewamusic.com](https://int.gewamusic.com):
<https://int.gewamusic.com/downloads>

www.gewaelectronics.com

CONTENT

1	Safety Information	1
1.1	Symbols used in the Manual.....	1
1.2	Safety Precautions.....	1
1.3	Proper Handling.....	3
1.4	Improper Use [examples].....	3
1.5	CE Label.....	4
1.6	FCC Label/FCC Mark.....	5
1.7	Regulatory Information - Canada.....	6
1.8	Recycling.....	8

- 2 Parts supplied with the GEWA G9..... 9**

- 3 Assembly Instructions..... 10**
 - 3.1 Mount Bracket Assembly..... 10
 - 3.2 Connect your Equipment to the Console..... 10
 - 3.2.1 Front Panel..... 10
 - 3.2.2 Rear Panel..... 11
 - 3.2.3 Cymbals..... 12
 - 3.2.3.1 GEWA Cymbals..... 12
 - 3.2.3.2 Other Manufacturers..... 12
 - 3.2.3.3 Analogue Cymbals with separate Bell Channel..... 13

- 4 Explanation of Hardware Functions 14**

- 5 Starting the Device 15**

- 6 Before you start..... 16**
 - 6.1 Trigger Setup..... 16
 - 6.2 Bluetooth, Wi-Fi and Auto Off 17

- 7 User Interface - Basics 18**
 - 7.1 Easy Mode..... 18
 - 7.2 Disable Easy Mode 18
 - 7.3 Working with Dials 19
 - 7.4 Interface Structure..... 20
 - 7.5 Touch Screen..... 21
 - 7.5.1 Keyboard..... 21

- 8 Performance 23**
 - 8.1 Module 1..... 23
 - 8.1.1 Drum Kit..... 23

8.1.1.1	Managing Drum Kits (Presets)	24
8.2	Module 2	25
8.2.1	Kit Options	25
8.2.1.1	Trigger Detection	25
8.2.1.2	Peak Detection	26
8.2.1.3	Snare Style (Rimshot, Crosstick and X-Fade)	27
8.2.2	Mixer	27
8.3	Module 3	27
8.3.1	Song Player	27
8.3.1.1	File Select Browser	28
8.3.1.1.1	Properties	28
8.3.1.1.2	Open Audio Files	29
8.3.1.2	Song Player Features	30
8.3.1.2.1	Timeline	30
8.3.1.2.2	Play Modes	31
8.3.1.2.3	External Song Players	31
8.3.1.2.4	Loop	31
8.3.1.2.5	Quick Record	31
8.3.1.2.6	Vari Speed	32
8.3.1.2.7	Song Volume	32
8.4	Module 4	32
8.4.1	Metronome	32
8.4.2	Visual Mode	33
8.4.3	Metronome Settings	34
8.4.3.1	Metronome Sound	34
8.4.3.2	Tap Channel	34
9	Kit Editor	37
9.1	Module 1	37
9.1.1	Channel Select	37
9.1.1.1	Input Channels	38
9.1.1.2	Auto Select	38
9.1.1.3	Peak Detection	39

9.2	Module 2	39
9.2.1	Instrument Select	39
9.2.1.1	Drum Kit	39
9.2.1.2	Pad Components	40
9.2.1.3	Sound Select	40
9.2.1.4	Sound Browser – Properties	41
9.2.1.4.1	Source – Internal	41
9.2.1.4.2	Source – Import	41
9.2.1.4.3	Assigning Sounds – Sound Grouping	41
9.2.1.5	Drum Kit Presets – Parameters	44
9.2.1.6	Preset Management – Elements	46
9.2.1.6.1	Loading Drum Kits	47
9.2.1.6.2	Saving and Overwriting Drum Kits	47
9.2.1.6.3	Rename Drum kits	48
9.2.1.6.4	Deleting Drum Kits	48
9.2.1.7	Drum Kit Exchange	48
9.2.1.7.1	Export	49
9.2.1.7.2	Import	50
9.2.2	Pad MIDI Settings	51
9.3	Module 3	52
9.3.1	Mix / Effect Sends	52
9.3.1.1	Volume (Component)	52
9.3.1.2	Panning (Input Channel)	52
9.3.1.3	Effects	53
9.3.2	Sound Edit	53
9.3.2.1	Tuning Coarse	53
9.3.2.2	Tuning Fine	53
9.3.2.3	Attack	54
9.3.2.4	Release	54
9.3.3	Second Sound Edit	55
9.3.3.1	Volume Second Sound	55
9.3.3.2	Tuning	55
9.3.3.3	Second Sound Select	55
9.3.3.4	Assignment of Second Sounds	56

9.3.4	Hi-Hat Volume Control	57
9.4	Module 4	57
9.4.1	Pad Equalizer / Compressor	57
10	Effects	61
10.1	Effect Parameters	61
10.2	Effects Modules – Mutual Parameters	62
10.3	Effect Preset Parameters	63
10.4	Effects Presets	64
10.4.1	Loading Presets	65
10.4.2	Saving New Presets	65
10.4.3	Direct Storage of Parameter Values	65
10.4.4	Preset Overwrite	66
10.4.5	Renaming Presets	66
10.4.6	Deleting User Presets	66
10.5	Module 1	67
10.5.1	FX1 Ambience Samples	67
10.6	Module 2	67
10.6.1	FX 2 Instrument Reverb	67
10.6.1.1	Reverb Types and Parameters	68
10.7	Module 3	69
10.7.1	FX3 Room Reverb	69
10.8	Module 4	70
10.8.1	FX 4 Multi Effects	70
11	Trigger Settings	77
11.1	Module 1	77
11.1.1	Trigger Detection	77
11.1.1.1	Input Channels	78
11.1.1.2	Auto Select	79
11.1.1.3	Peak Detection	79

11.2	Module 2	79
11.2.1	Trigger Selection	79
11.2.1.1	Setup	79
11.2.1.1.1	Standard Setups	80
11.2.1.2	Trigger Bank	81
11.2.1.3	Presets – Setup and Trigger Bank	82
11.2.1.3.1	Loading Presets	84
11.2.1.3.2	Saving New Presets	84
11.2.1.3.3	Direct Storage of Parameter Values - Setups	84
11.2.1.3.4	Overwrite Presets	85
11.2.1.3.5	Renaming Presets	85
11.2.1.3.6	Deleting User Presets	85
11.2.1.4	Pad Components	86
11.3	Module 3	86
11.3.1	Trigger Settings	89
11.3.1.1	Gain	89
11.3.1.2	Threshold	90
11.3.1.3	High level	91
11.3.1.4	Scan time	91
11.3.1.5	Retrigger Mask	91
11.3.1.6	X-Talk	92
11.3.1.6.1	Adjusting X-Talk Parameters	92
11.3.1.7	High Position [Hi-Hat Pedal only]	92
11.3.1.8	Low Position [Hi-Hat Pedal only]	92
11.3.1.9	Chick Sensitivity [Hi-Hat Pedal only]	93
11.3.1.10	Pedal Calibration [Hi-Hat Pedal Only]	93
11.3.2	Advanced Settings	95
11.3.2.1	Dyn Level & Dyn Time	95
11.3.2.2	Splash Sensitivity [Hi-Hat Pedal only]	95
11.3.2.3	Trigger Type	95
11.3.2.4	Curve Settings	96
11.3.2.4.1	Assigning Preset Curves	96
11.3.2.5	Curve Editor	99
11.3.2.5.1	Creating Custom Curves	100

11.4	Module 4	102
11.4.1	Trigger Monitor	102
11.4.1.1	Pad Monitor	103
11.4.1.2	X-Talk Monitor	103
12	General Settings	105
12.1	Module 1	105
12.1.1	Master Outs	106
12.1.2	Direct Outs	106
12.1.3	Digital In/Out	107
12.1.4	Routing Drums & Routing Others	107
12.1.4.1	Editing the Routing Matrix	109
12.1.4.2	Presets – Routing	110
12.1.4.2.1	Loading Presets	111
12.1.4.2.2	Saving New Presets	111
12.1.4.2.3	Overwrite Presets	112
12.1.4.2.4	Renaming Presets	112
12.1.4.2.5	Deleting User Presets	112
12.2	Module 2	113
12.2.1	Master Channel Headphone Monitor Outs	113
12.2.1.1	Equalizer	113
12.2.1.1.1	Parameters and Description	114
12.2.1.1.2	Editing EQ Curves	114
12.2.1.2	Compressor	115
12.2.1.2.1	Parameters and Description	116
12.2.1.2.2	Editing Compressor Curves	117
12.2.1.3	Presets – Equalizer and Compressor	117
12.2.1.3.1	Loading Presets	119
12.2.1.3.2	Saving New Presets	119
12.2.1.3.3	Overwrite Presets	119
12.2.1.3.4	Renaming Presets	119
12.2.1.3.5	Deleting User Presets	120
12.2.2	Control	120
12.3	Module 3	121

12.3.1	MIDI	122
12.3.1.1	Global MIDI Settings [Soft Thru]	122
12.3.1.1.1	Routing MIDI Signals	122
12.3.1.1.2	Local Control	123
12.3.1.1.3	MIDI Channel	124
12.3.1.1.4	MIDI Control	124
12.3.2	Drumkit Program Change	125
12.3.2.1	Program Pairing	125
12.3.2.2	Channels [Transmit/Receive]	126
12.4	Module 4	127
12.4.1	Device	127
12.4.1.1	Auto Off	127
12.4.1.2	Knob Brightness	127
12.4.1.3	Start Screen	127
12.4.1.4	UI Theme	128
12.4.2	Wi-Fi	128
12.4.3	Bluetooth	129
12.4.3.1	Custom Bluetooth Names	129
12.4.4	Factory Reset	130
12.4.5	Information	131
12.4.6	Update	131
12.4.6.1	Download - Firmware and Manuals	131
12.4.6.1.1	Downloads from gewamusic.com	131
12.4.6.1.2	Direct Download via Module	132
12.4.6.2	Update your Device	133
12.4.6.2.1	Software Update via USB	133
12.4.6.2.2	Update Routine Via Module	134
13	Tools	135
13.1	On Stage	135
13.1.1	Tiles - Assignable Media Types	136
13.1.2	Editing Tiles - Assign Expressions for Media Types	137
13.1.3	Setlist Presets	138
13.1.3.1	Loading Setlists	138

13.1.3.2	New Setlists.....	139
13.1.3.3	Save Setlists.....	139
13.1.3.4	Rename Setlists.....	140
13.1.3.5	Delete Setlists.....	140
13.1.4	Working with Setlists.....	140
13.1.4.1	Pdf Viewer.....	141
13.2	PDF Reader.....	142
13.2.1	File Select Browser.....	143
13.2.1.1	Properties.....	143
13.2.1.2	Open Pdf Files.....	144
13.2.2	Bookmarks and Thumbnails.....	144
13.3	File Manager.....	145
13.3.1	File Manager vs. Import Tool.....	146
13.3.2	Screen Layout and General Properties.....	146
13.3.3	Task Bar.....	147
13.3.4	Collections – Concept and Overview.....	148
13.3.5	Compiling Collections.....	150
13.3.6	Selection Rules and Methods.....	150
13.3.6.1	Parenting.....	150
13.3.6.2	Membership of a Collection.....	151
13.3.6.3	Refresh vs. Uncheck All.....	151
13.3.7	Collection Based Tasks –Move/Copy/Delete.....	151
13.3.8	Organize – New Folder and Rename.....	152
13.3.8.1	New Folder.....	152
13.3.8.2	Rename.....	152
13.3.9	History – Undo and Redo.....	153
13.3.10	Closing the App.....	153
13.4	Utilities.....	153
13.4.1	Search.....	153
13.4.1.1	Properties.....	153
13.4.1.2	Conception.....	154
13.4.2	Filter Manager.....	155

13.4.2.1	Properties.....	156
13.4.2.2	Filters and Sorting Options.....	157
13.5	Import Tool.....	158
13.5.1	Importer.....	158
13.5.2	Import Custom Samples [Single Layer].....	159
13.5.3	Import Sounds from the Cloud.....	161
13.5.4	Delete Sounds from the Library.....	161
13.5.5	Import Limits and Sound Management.....	162
13.5.5.1	Facts.....	162
13.5.5.2	Scenarios for Import Limitations.....	162
13.5.5.3	Reacting to import limits.....	163
13.5.5.4	Data loss.....	163
13.6	Shop.....	163
13.6.1	Connecting to the Cloud.....	164
13.6.2	Billing Process.....	165
13.6.3	Digital Property Rights.....	165
13.6.4	Sale or exchange of a G9 device.....	165
14	Useful Information.....	167
14.1	Explanation of Terms.....	167
14.2	Warranty.....	168
15	Troubleshooting and possible Solutions.....	169
16	Technical Data.....	170

Valued Customer,

Thank you for purchasing our top-quality GEWA G9 Drum Workstation!

The G9 drum workstation is an E-Drum that gives you a highly impressive sound and playing experience, while offering a huge extra set of additional and easy to use sounds and features.

Your safety is very important to us! So please read the safety information carefully and take good note of the given information.

We suggest you keeping this user manual at a safe and known place, and to pass it on to a new owner or user of your G9 Drum Workstation.





1 SAFETY INFORMATION

The manufacturer cannot be held liable for injury to persons or damage to property resulting from incorrect use of the device!

Only use your digital drum set in accordance with the instructions given here!

1.1 SYMBOLS USED IN THE MANUAL

The following symbols are used to signal risks and to give advice:

Level of Risk	Symbol		Definition
Serious Injuries		WARNING	Failure to observe the following safety instructions can result in serious injury or death.
Electrical Hazard		WARNING	Failure to observe the following safety instructions can result in serious injury or death by electrical hazards.
Minor Injuries and device damage		CAUTION	Failure to observe the following safety instructions can result in minor injuries and/or device damage.
Notes		NOTE	Helps to avoid the injuries and damaging of the drum console.
Tip		HINT	Hints for optimized handling of your GEWA digital drum console.

1.2 SAFETY PRECAUTIONS

Always follow the safety precautions given here. Non-compliance with the safety precautions may have serious consequences:

- Serious injury or even lethal accidents
- Electric Hazard
- Short circuits
- Damage
- Fire

Further and other risks are possible; therefore, this list does not claim to be complete.



WARNING Electric Hazard



- Do not expose the apparatus to dripping or splashing.
- Do not place objects filled with liquids, such as vases or glasses on or near the apparatus.
- The mains plug shall remain readily operable. Never use damaged power supplies/cords.
- Install power supplies/cables firmly to avoid the risk of damage.
- Even low electric currents can lead to serious injuries and even death!
- Never open the drum console.
- Never insert water or liquids into the drum console.
- Never clean the digital drum console with a wet cloth.
- Never plug in or unplug the console with wet hands and never pull on the cable as it may be damaged.
- If liquids or water accidentally get into the drum console, unplug it immediately. In all the above cases have the digital drum console checked by your authorized GEWA customer service.
- Never use damaged power supplies/cables.
- Protect the power cord from being walked or pinched, particularly at plugs, convenience receptacles, and at the point where they exit from the apparatus.



WARNING Fire Prevention

- Ensure a minimum distance of 7 cm (three inches) around the apparatus for sufficient ventilation.
- Ensure that the ventilation is not impeded by covering the ventilation openings with items such as newspapers, table-cloths, curtains, etc.
- Do not place naked flame sources, such as lighted candles on the apparatus. Candles or oil lamps can tip over and cause a fire.
- Never bring open fire on or near to the digital drum set.
- Do not install near any heat sources such as radiators, heat registers, stoves, or other apparatus (including amplifiers) that produce heat.
- Use the apparatus only in moderate climates (not in tropical climates).



WARNING Unusual Behavior



- Switch the drum console off or unplug it immediately if:
 - there is a sudden loss of sound while the drum console is in use.
 - the console emits an unusual smell or smoke.
- It is essential to have the drum console checked by your GEWA customer service.



CAUTION Damaging the Apparatus

- Mismatching electrical voltages can damage the console. Operate the digital drum console only within the correct voltage range (marked on the corresponding specs plate).
- Only use the power supply and power cable supplied with the device.
- Never place the power cable near to heat sources such as radiators or radiant heaters.
- Do not sharply bend the cable, or damage it otherwise (! risk of cable break!).
- Position the power cable in a way to avoid tripping or anything heavy rolling over it.
- Do not place any objects on the power cable.
- Check the power supply regularly and remove any visible dust or dirt on the device.



CAUTION Damage by Thunderstorms



- Thunderstorms can produce electrical surges able to damage your drum console.
- During thunderstorms, or if you will not use your drum console for a while, we suggest you unplugging your console completely from the electrical system.

1.3 PROPER HANDLING

- Please keep your digital drum console in a dry environment.
- Audio accessories for audio playback (connected to the in- or output of the console) or for data communication can be connected. Accessories must match the relevant technical specifications (see section 16, Technical Data)
- Only and always use GEWA certified power adapters, and make sure that they are properly attached and connected. The power supply used must also meet the country voltage specifications (check plate on the adapter).
- The digital drum set is only to be used as originally delivered. Any modifications to the drum set are not allowed and result in a complete loss of warranty.
- The digital drum set must be set up on safe weight-bearing, stable and even ground or platform able to support the weight (please therefore see section 16, Technical Data).

1.4 IMPROPER USE (EXAMPLES)

- Exposing the digital drum console to an open air or moist/rainy environment.
- Setting up the digital drum set in damp rooms.
- Using power supplies not authorized by GEWA music or connecting the console to an electrical outlet despite mismatching local voltage specifications.
- Playing the digital drum set close to electrical or electronic devices, such as stereo systems, TV sets, radios or mobile phones. These devices can cause interferences and seriously effect and decrease the sound quality of your GEWA digital drum set.
- Using extensively long audio leads can likewise interfere with the sound quality.
- Transport and setup up in conjunction with strong vibrations and shocks, dust and heat exposure (e.g.in vehicles or direct sunshine or both), should also definitely be avoided.
- Playing on the display with drumsticks or other solid objects can damage the protective glass. Only use your fingers and ensure enough distance between module and the connected equipment.



The manufacturer cannot be held liable in case of damages in the following cases:

- **Non-compliance with the safety instructions**
- **Improper handling**
- **Connecting incompatible in/output devices etc. or other 3rd party interface devices.**

1.5 CE LABEL



Your GEWA G9 Drum Console complies with the requirements of the EU directives:

Directive 2014/53/EU

Standards to which conformity is declared:

EN55020:2007+A11:2011

EN55024:2010

EN55032:2012

EN61000-3-2:2014

EN61000-3-3:2013

EN301489-17:V3.2.0

EN60065:2014

EN62311:2008

2009/125/EC: 2009 (EC Regulation 1275/2008 + 801/2013)

EN300328:V2.1.1

EN301893:V2.1.1

Compliance with the above directives is confirmed by the CE label on the device. The declaration of conformity can be viewed at the following address:

GEWA music GmbH
Oelsnitzer Straße 58
08626 Adorf
GERMANY

1.6 FCC LABEL/FCC MARK



This product is certified by the Federal Communications Commission (FCC) and is identifiable by its FCC-ID: 2APT-V-GEWAG9. It contains a modular approved transmitter module with FCC-ID: A8TBM64S2.

This information is also shown on the permanent label at the bottom side of each device.

The built-in Wireless LAN module is only a DFS Client and is not capable of performing Dynamic Frequency Selection (DFS) itself.

RF Exposure Statement

This equipment complies with FCC radiation exposure limits set forth for an uncontrolled environment and meets the FCC radio frequency (RF) Exposure Guidelines. This equipment has low levels of RF energy that is deemed to comply without maximum permissive exposure evaluation (MPE).

This Class B digital device complies with part 15 of the FCC Rules.

Operation is subject to the following two conditions:

- (1) This device may not cause harmful interference, and
- (2) this device must accept any interference received, including interference that may cause undesired operation.

NOTE:

This equipment has been tested and found to comply with the limits for a Class B digital device, pursuant to part 15 of the FCC Rules. These limits are designed to provide reasonable protection against harmful interference in a residential installation. This equipment generates, uses and can radiate radio frequency energy and, if not installed and used in accordance with the instructions, may cause harmful interference to radio communications. However, there is no guarantee that interference will not occur in a particular installation. If this equipment does cause harmful interference to radio or television reception, which can be determined by turning the equipment off and on, the user is encouraged to try to correct the interference by one or more of the following measures:

- Reorient or relocate the receiving antenna.
- Increase the separation between the equipment and receiver.
- Connect the equipment into an outlet on a circuit different from that to which the receiver is connected.
- Consult the dealer or an experienced radio/TV technician for help.

Warning: Any changes or modifications not expressly approved by GEWA music GmbH could void the user's authority to operate this equipment.

1.7 REGULATORY INFORMATION - CANADA

IC

ENGLISH

This product is certified by Innovation, Science and Economic Development (ISED) and is identifiable by IC: 23946-GEWAG9. It contains a modular approved transmitter module with IC: 12246A-BM64S2 as well as license-exempt transmitter(s)/receiver(s) that comply with Innovation, Science and Economic Development Canada's license-exempt RSS(s).

ICES-003 Class B Notice

This Class B digital device complies with Canadian CAN ICES-003. Operation is subject to the following two conditions:

- (1) This device may not cause harmful interference, and
- (2) this device must accept any interference received, including interference that may cause undesired operation.

This information is also shown on the permanent label at the bottom side of each device.

RF Exposure Statement

This equipment complies with ISED radiation exposure limits set forth for an uncontrolled environment and meets the RSS-102 of the ISED radio frequency (RF) Exposure rules. This equipment has low levels of RF energy that are deemed to comply without maximum permissible exposure evaluation (MPE).

LE-LAN Device Notice

This product complies with the rules for license-exempt transmitter(s)/receiver(s) covered by the RSS-247 and RSS-Gen (LE-LAN Device). Operating in the band 5150-5250 MHz, this device is **only for indoor use** to reduce the potential for harmful interference to co-channel mobile satellite systems. It possesses only DFS Client properties and is not capable of Dynamic Frequency selection (DFS) itself. The programming is realized with fixed RF parameters while the wizard structure of the firmware does not allow for reprogramming by the operator.

Standards to which compliance is declared can be found under the following links:

RSS-Gen: <http://www.ic.gc.ca/eic/site/smt-gst.nsf/eng/sf08449.html>

RSS-102: <http://www.ic.gc.ca/eic/site/smt-gst.nsf/eng/sf01904.html>

RSS-247: <http://www.ic.gc.ca/eic/site/smt-gst.nsf/eng/sf10971.html>

IC

FRANÇAIS

Ce produit est certifié par Innovation, Sciences et Développement Économique (ISDE) et est identifiable par IC: 23946-GEWAG9. Il contient un module d'émetteur approuvé avec IC: 12246A-BM64S2 ainsi que des émetteur(s)/récepteur(s) exempts de licence qui sont conformes aux CNRs applicables de Innovation, Sciences et Développement économique Canada.

Avis NMB-003, Classe B

Le présent appareil numérique de la classe B est conforme à la norme NMB-003 d'Industrie Canada.

L'exploitation est autorisée aux deux conditions suivantes:

- (1) l'appareil ne doit pas produire de brouillage, et
- (2) l'utilisateur de l'appareil doit accepter tout brouillage radioélectrique subi, même si le brouillage est susceptible d'en compromettre le fonctionnement.

Ces informations sont également affichées sur l'étiquette permanente en bas de chaque dispositif.

Déclaration concernant l'exposition humaine aux RF

Cet équipement est conforme aux limites d'exposition humaine aux radiofréquences d'ISDE exposés pour environnement contrôlé et satisfait au CNR-102. Cet équipement possède niveaux d'énergie de radiofréquences bas que sont considérés d'être conforme sans l'évaluation des valeurs d'intensité maximale de champ des RF.

Avis Dispositif RL-EL

L'émetteur/récepteur exempt de licence contenu dans le présent appareil est conforme au CNR-247 et CNR-Gen d'Innovation, Sciences et Développement économique Canada applicables aux appareils radio exempts de licence (Dispositif RL-EL). En fonctionnant dans la bande de 5 150 à 5 250 MHz, ces dispositifs sont réservés **uniquement pour une utilisation à l'intérieur** afin de réduire les risques de brouillage préjudiciable aux systèmes de satellites mobiles utilisant les mêmes canaux. En possédant exclusivement propriétés d'un client SDF, ce dispositif n'est pas capable de faire une sélection dynamique des fréquences (SDF) soi-même. La programmation est réalisée avec des valeurs de paramètres des RF fixes tandis que la structure assistant du logiciel ne permet pas de reprogrammation par l'utilisateur.

Conformité déclarée aux normes suivantes:

CNR-Gen: <http://www.ic.gc.ca/eic/site/smt-gst.nsf/fra/sf08449.html>

CNR-102: <http://www.ic.gc.ca/eic/site/smt-gst.nsf/fra/sf01904.html>

CNR-247: <http://www.ic.gc.ca/eic/site/smt-gst.nsf/fra/sf10971.html>

1.8 RECYCLING











In case your digital drum console needs to be disposed, take it to your local community waste management service location (e.g. disposal companies, recycling centers).

The displayed symbol requires that devices labeled with this symbol must be disposed separately from household waste. Under the Electrical and Electronic Equipment Act, owners of devices marked with this symbol are required by federal law to deposit waste electrical and electronic equipment in a separate waste collection.

Please help us with your contribution to protect the environment by not depositing your old electric equipment with the general household waste.

2 PARTS SUPPLIED WITH THE GEWA G9

The G9 in original packaging contains the following items. Please check carefully the completeness of the purchased product:

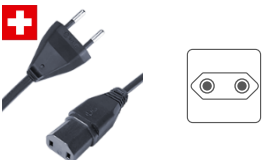
<p>G9 Drum Workstation</p>  <p>1x</p>	<p>10,5 – 12,7 mm Mount Bracket</p>  <p>1x</p>	<p>Product ID Card</p>  <p>1x</p>
<p>USB Stick</p>  <p>1x</p>	<p>Quick Start Guide (Multilingual)</p>  <p>1x</p>	
<p>Power Cords 2 m (IEC C18)</p>		
<p>Type C (CEE 7/17) [EU CU IL IN]</p>  <p>1x</p>	<p>Type A [US CA CU JP TW]</p>  <p>1x</p>	<p>Type G [UK]</p>  <p>1x</p>
<p>Type I [AU AR NZ]</p>  <p>1x</p>	<p>Type C (CEE 7/16) [CH]*</p>  <p>1x</p>	

*Only for use in Switzerland! | Nur zur Verwendung in der Schweiz! | Pouze pro použití ve Švýcarsku! | Solamente para el uso en Suiza! | Seulement pour l'usage en Suisse! | Solo per l'uso in Svizzera! | Tylko do użytku w Szwajcarii! | Apenas para uso na Suíça!

3 ASSEMBLY INSTRUCTIONS

3.1 MOUNT BRACKET ASSEMBLY

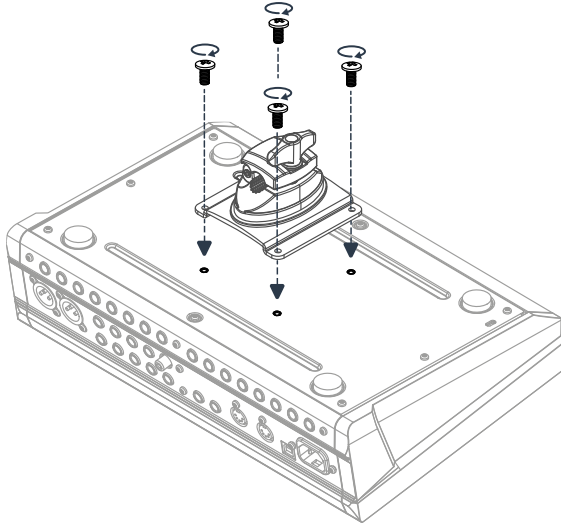

3.2 CONNECT YOUR EQUIPMENT TO THE CONSOLE

3.2.1 FRONT PANEL

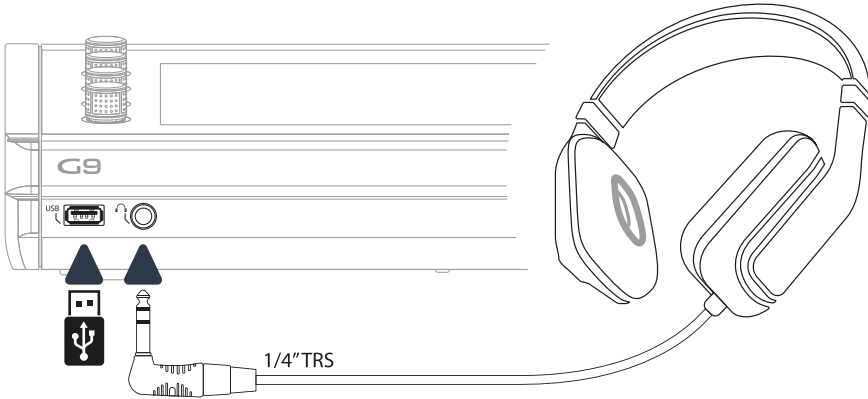

3.2.2 REAR PANEL

Make sure the power is OFF when connecting the drum module with external devices.

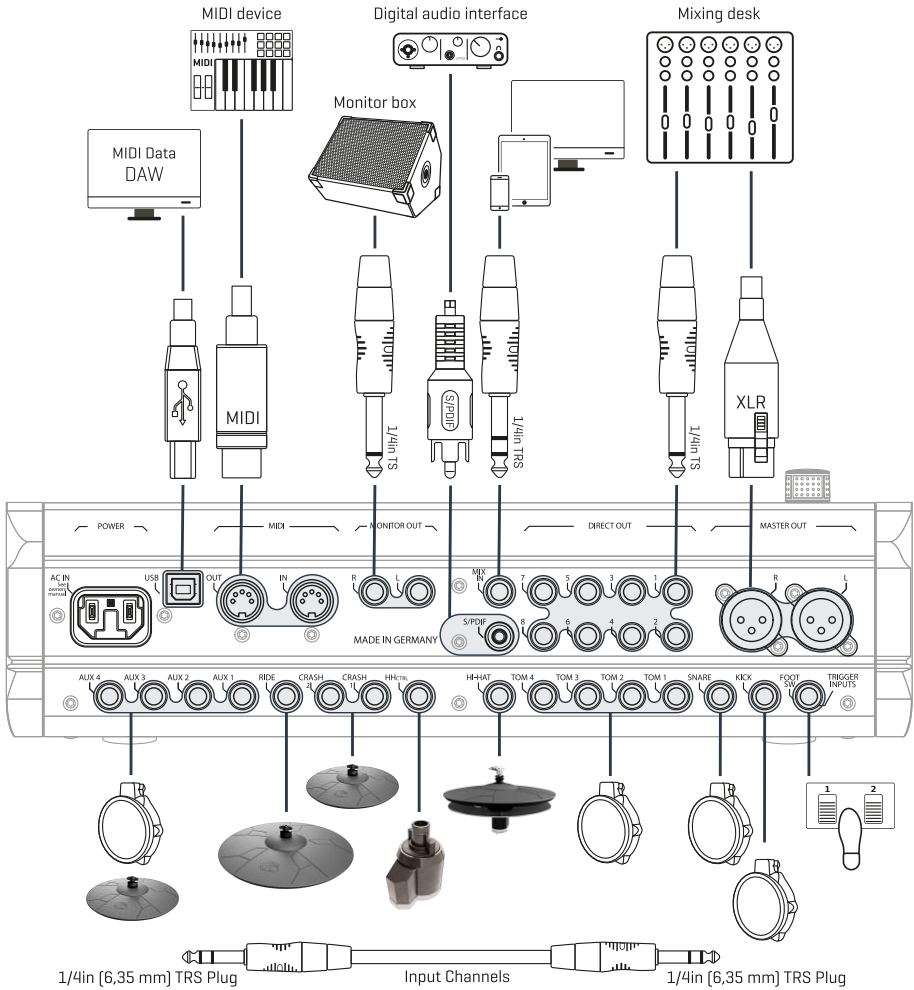

3.2.3 CYMBALS

3.2.3.1 GEWA CYMBALS

GEWA Cymbals are equipped with two Stereo jacks (6,35 mm - 1/4" TRS standard). In conjunction with GEWA modules only the jack closest to the middle hole of the cymbal is relevant.

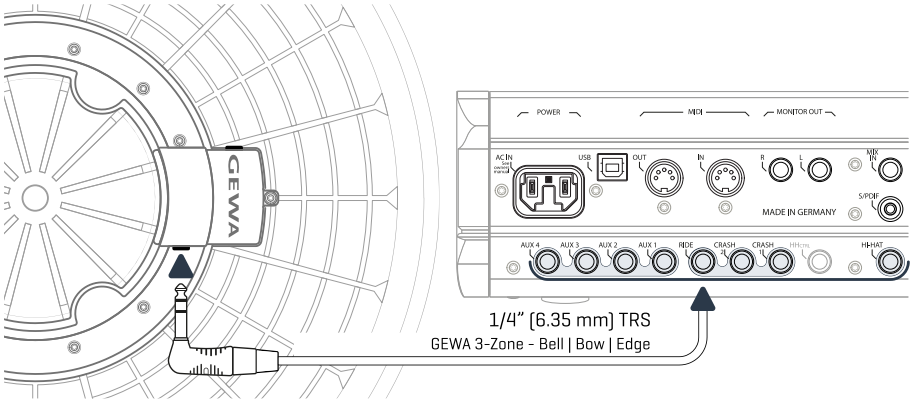

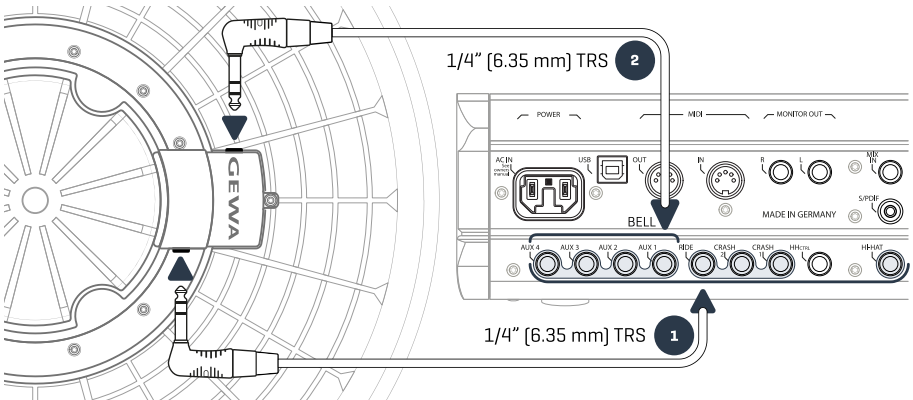

3.2.3.2 OTHER MANUFACTURERS

Regarding analogue cymbals from other manufacturers, use the corresponding input jacks as follows:



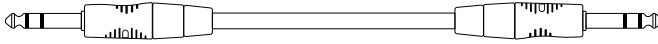

Connecting other Cymbals



Cymbal Type	Components	Components	Trigger Type (Trigger Settings)
	1	2	
Single Zone Cymbals	Edge	Not Used	Single/Dual
2-Zone Cymbals	Bow Edge	Not Used	Dual
3-Zone Cymbals without extra Bell output	Bow Edge Bell	Not Used	Dual
3-Zone Cymbals with extra Bell output	Bow Edge	Bell	3Way
 Hint	<i>Different cymbal types will only work in conjunction with the matching Trigger Type. For more information please refer to section 11.3.2.3 Trigger Type on page 95.</i>		

3.2.3.3 ANALOGUE CYMBALS WITH SEPARATE BELL CHANNEL

Cymbal Pads with extra Bell output can connect to GEWA consoles in different ways. See the following table for all possible pairs of **Bow/Edge** and **Bell** channel combinations:

GEWA Inputs for analog Cymbals with separate Bell Channel		
	Cymbal Component	
	Bow/Edge	Bell
Input Channel	Ride	Aux 1
	Aux 1	Aux 2
	Aux 2	Aux 3
	Aux 3	Aux 4
 Hint	<i>Cymbals with separate Bell channel require Trigger Type 3Way to be set for the Bow/Edge Input Channel (Bow component). For more information please refer to section 11.3.2.3 Trigger Type on page 95.</i>	

All other analogue pads connect as shown in the rear panel.

4 EXPLANATION OF HARDWARE FUNCTIONS

The functionality of the physical dials and buttons can vary depending on the state of user interface (software). Some buttons are customizable. This section describes the standard functionalities when starting the device.

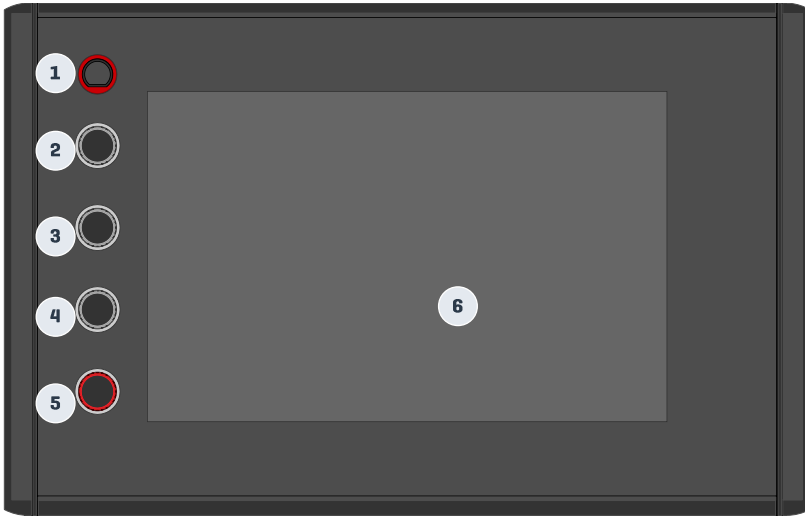

Panel & Display – Standard Functions

1	Power Button
	Turns Power ON and shuts down the device
2	Hardware Dial
	Metronome Tempo
3	Hardware Dial
	Monitor Out / Mix Input Volume
4	Hardware Dial
	Headphone Volume
5	Home Button
	Master Volume (XLR Outputs)
	Returns to Start Screen
6	Touch Display
	Various Gestures and Features

5 STARTING THE DEVICE

- 1 Connect the DC plug of the AC power adaptor to the DC IN jack on the rear panel.
- 2 Connect the mains plug to the electrical outlet.

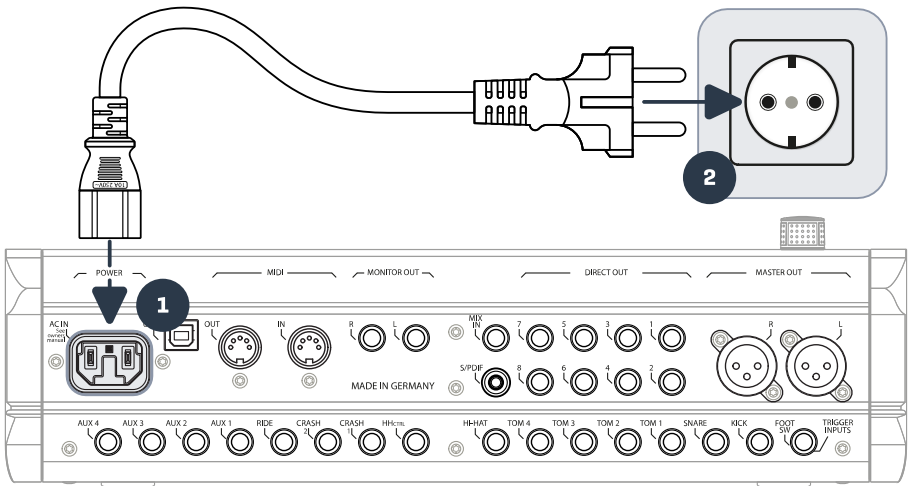

- 3 With the cord connected correctly the **[Power]** button lights up in red. The device is in stand-by mode and ready to be explored. Press the **[Power]** button to boot the apparatus.
- 4 Wait for the device to boot

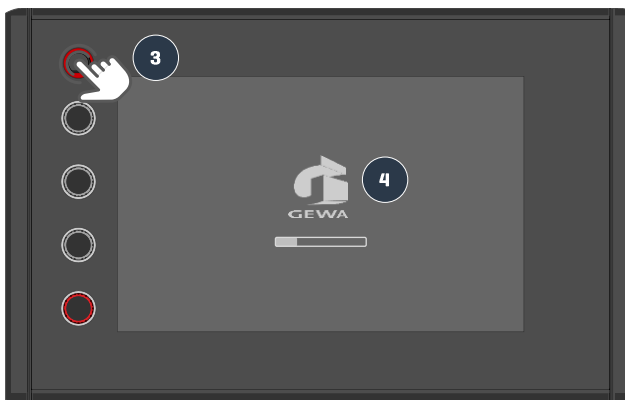

- i Note:** In order to save energy, the G9 provides an "Auto Power" feature. With this function, the Workstation will shut down automatically being left idle for more than 30 (default) minutes. Change this property in **General Settings** → **Module 4** → **Device** → **Auto Off**

6 BEFORE YOU START....

This section gives a brief introduction to important global settings of your G9 Drum Workstation.

6.1 TRIGGER SETUP

Your GEWA Drum Console provides trigger presets for different pad configurations available. If you have purchased your G9 with a prepacked pad configuration, choose one of the following setups for satisfactory trigger performance:

GEWA STUDIO | GEWA PRO 5 | GEWA PRO 6

Follow the safety instructions of sections 1-5 of the Quick Start Guide/Owner's Manual and proceed as follows:

1		Push Power Button 	Start G9
2		Tap Advanced Button 	
3		Trigger Settings 	
4	2 X	Load Setup 	

6.2 BLUETOOTH, WI-FI AND AUTO OFF

Access the wireless options and shut down timer in **General Settings**.

Bluetooth Password: **4392**

1



Push Power Button

Start G9

2



Tap Advanced Button



3



General Settings



Bluetooth

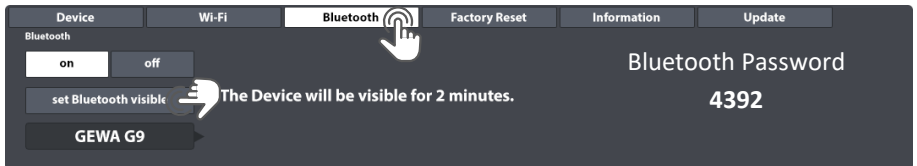

Bluetooth Password: **4392**

Wi-Fi

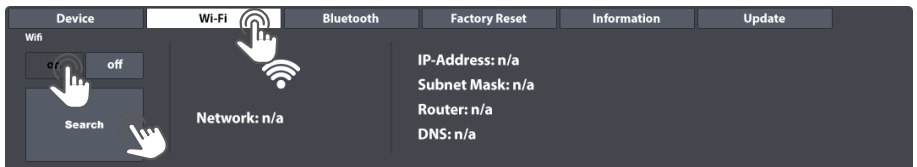

Network: n/a

IP-Address: n/a
Subnet Mask: n/a
Router: n/a
DNS: n/a

Auto Off

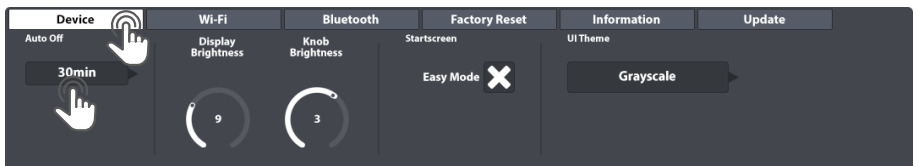

Auto Off: 30min

Display Brightness: 9

Knob Brightness: 3

Easy Mode: **X**

UI Theme: Grayscale

7 USER INTERFACE - BASICS

This section covers general aspects of using the G9 Drum Workstation. You will learn how to work with physical and digital **Dials**, learn about the **Interface Structure** and gain a fundamental understanding of using the built in **Touch Screen**. Please choose a topic from the submenu in this section.

7.1 EASY MODE

By default, the G9 boots in a graphical screen with the most basic features such as:

- Select preset drum Kits (Tap on Kit name or **[+]** and **[-]**)
- Tap on Drums and Cymbals to preview Sounds
- Basic Metronome features (on, off and tempo dial)
- Pad volume mixer
- Output volume dials (Master, Headphone, Monitor Out and Mix Input)



All these features can be tweaked further in the **Advanced Modes**, which are accessible by tapping the **[Advanced]** button in the bottom right corner. All changes made in the advanced modes will immediately take effect in the Easy Mode. Return to the Easy Mode by pressing the **[Home]** button (red hardware dial).

7.2 DISABLE EASY MODE

If desired, you can replace the **Easy Mode** with the **Performance Mode**.

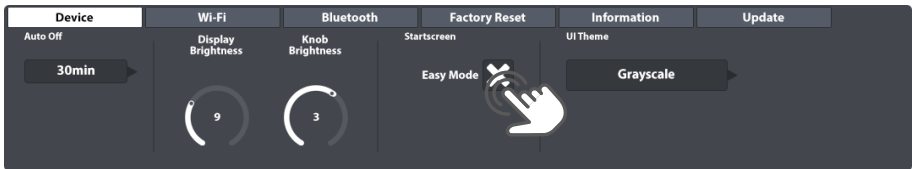

To do so proceed as follows:

1. Tap the **[Advanced]** button.
2. Go to: **General Settings → Module 4 → Device → Start Screen**
3. Uncheck "Easy Mode"

i *Hint: Unchecking "Easy Mode" will affect the start screen as well as the functionality of the [Home] button.*

7.3 WORKING WITH DIALS



To get started push the **[Red Dial]** once to access the Easy Mode screen. In addition to the touch screen, we have added physical dials for key functions, which are located on the left-hand side of the screen. The red dial at the bottom controls the master volume (master out) and serves as the **home button**. No matter what - if you press the red dial you will be brought back to the Easy Mode. If you tap on **Master** next to the red dial, a volume bar appears which you can adjust by dragging your finger up or down. Double tapping on the bar will cause the fader to jump to its factory default value. Once you are happy with the master volume setting you can just tap on **[Master]** again to close the volume bar. Moving up, the next dial controls the **Headphone** volume, the third dial adjusts the **Mix Input** volume, and the uppermost dial controls the **Metronome** speed.



Please note that in the **Trigger Settings** mode the gray dials change function to **Head Gain**, **Head Threshold** and **High Level**, but still function in the same fashion as presented by the example of the **Master** volume.

7.4 INTERFACE STRUCTURE

The G9 is divided into several sections called **Modes**. By default, the console starts in **Easy Mode**. You can enter the **Advanced Modes** with a single tap on the **[Advanced]** button in the right bottom corner. Mode icons of the advanced modes are in the sidebar at the right-hand side of the screen. The G9 interface comprises 6 advanced modes:



Within a mode, all functions are divided into thematic **modules**. Modules are further divided into **function sets**. Active function sets are highlighted in UI Theme colors. Thus, the G9 menu hierarchy is structured as follows:

Mode → Module → Function Set → Function

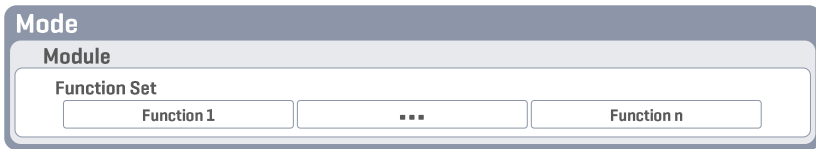

See this structure implemented in the screen layout of the G9:

Dials		Modules	Modes
	Module 1	<div style="border: 1px solid #ccc; padding: 5px;"> <div style="display: flex; justify-content: space-between;"> <div style="border: 1px solid #ccc; padding: 2px 10px;">Function Set</div> <div style="border: 1px solid #ccc; padding: 2px 10px;">Function Set</div> </div> <p style="text-align: center; margin-top: 10px;">Functions</p> </div>	
	Module 2		
	Module 3		
	Module 4		

7.5 TOUCH SCREEN

Many selections can be made utilizing the intuitive touch screen, such as finger dragging motions, number pad- and selection drop downs which can be accessed by tapping once. **Fields** with drop down menus have a little **Flag** (▶) attached to the right-hand side of their frames. When visible, **[+]** and **[-]** buttons allow for cycling through the underlying menu (One entry per tap).

The cross in the upper right-hand corner serves as an alternative for closing dialogues.

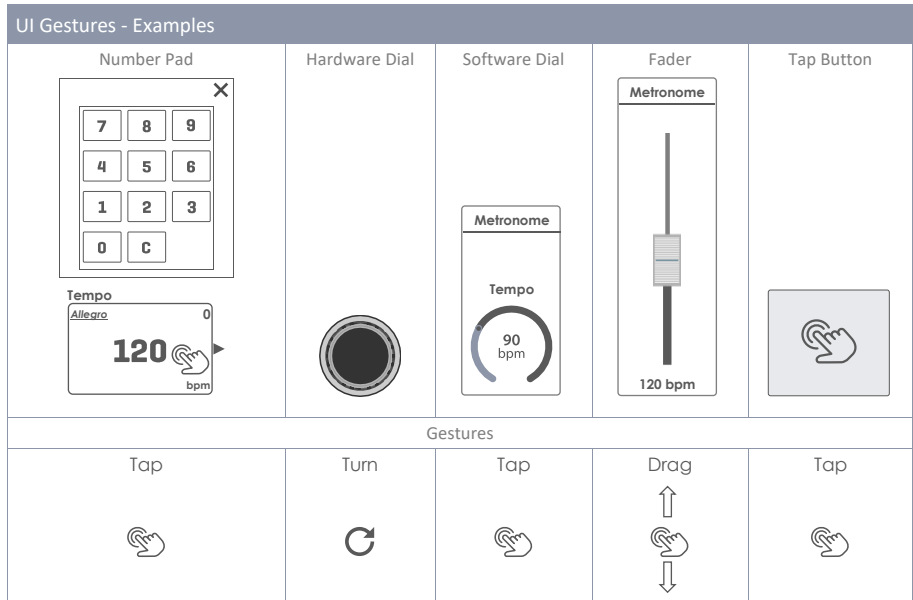



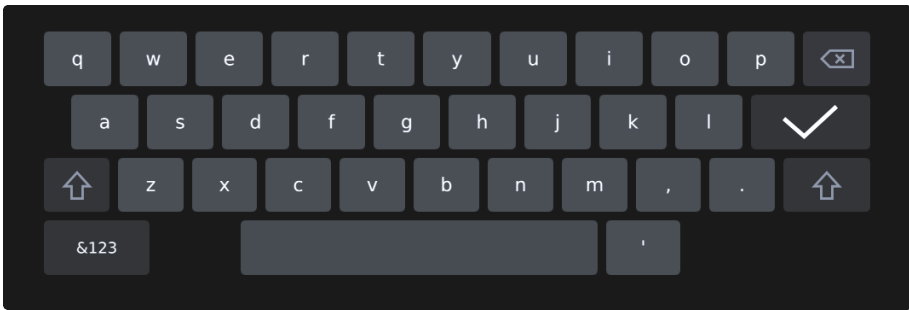

The **[Preview]** button at the bottom right of the screen enables you to listen to the sounds of the currently selected pad. Alternatively, you can preview sounds in dropdown lists as well. Select a pad or sound in a list and tap the preview button. Note that you don't need any pad to use this function.

7.5.1 KEYBOARD

On several occasions you will be confronted with the built-in keyboard. It works in the same way as you are accustomed to by using smart phones or tablets. The caps lock feature is the only noteworthy function. Tap the shift arrow once to switch to capital letters. After having entered the first letter the keyboard will switch automatically back to lower case letters. Activate caps lock by double tapping and deactivate capslock by tapping the shift key again.



Basic Keyboard Functions

Description	Single Tap	Double Tap
 Lower case	Lower case	Caps lock on
 Upper case	Next letter as Upper case	---
 Caps lock on	Upper Case (Caps Lock On)	---
 Delete	Delete letter in front of the cursor	---
 Confirm	Confirm and close keyboard	---

8 PERFORMANCE



The Performance Mode contains all key functions that center around actually playing drums. You will stay in this mode most of the time during your daily practice routine. This mode provides a metronome and a song player to help you master difficult exercises and songs. Here, we assume working trigger settings as well as finalized drum kits and presets. Choose your drum kit and decide whether you want to be accompanied by a song, metronome or both.

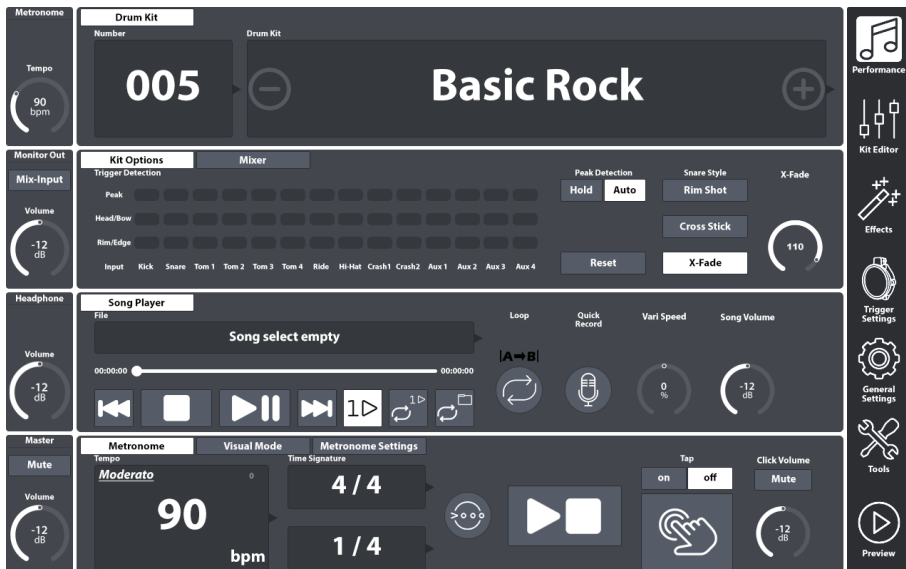

8.1 MODULE 1

8.1.1 DRUM KIT

The first section is the **Drum Kit** selector. This function set offers a variety of options for choosing a drum kit:

- 1 Tap once on the **[Drum Kit]** field and double tap to choose a kit from the list in the **Drum Kit Browser**. Use the filter functions provided to your advantage.
- 2 Drag your finger horizontally along the **Drum Kit** field.
- 3 Use **[-]** and **[+]** to move back and forth inside the drum kit library.
- 4 If you already know which kit you want to play you can also tap on the **[Number field]** and enter the new kit number directly. The number pad closes again by tapping once on the number field.

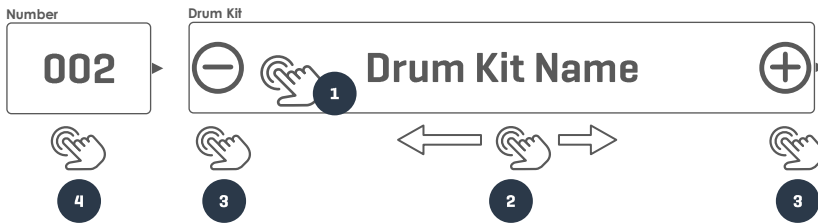

8.1.1.1 MANAGING DRUM KITS (PRESETS)

Tapping the [Drumkit Field] opens the **Drum Kit Browser** which provides a palette of functions to manage your drumkit library including the drum kit export.

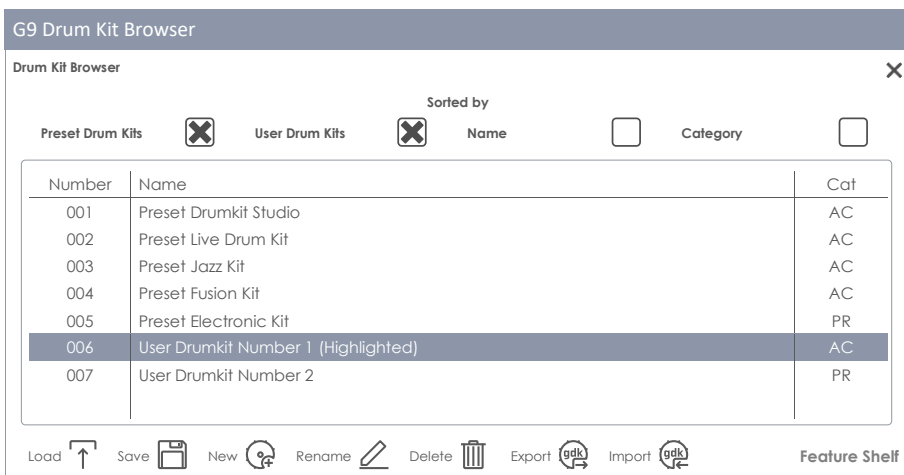



Depending on the set type (Factory or User Preset), the number of functions varies. In the **Drum Kit Browser**, the corresponding category is shown in the right column of the kit list, whereas the **feature shelf** is located at the bottom of the browser. The following table lists available functions by drum kit category. Alternatively select drum kits of different categories and observe how the **feature shelf** updates:

Preset Management – Drum Kit Browser							
Category	Function						
	Load	Save	Rename	New	Delete	Export	Import
Factory Preset							
User Preset							

When applying one of these functions to a drum kit, it is important to understand what you are creating, saving, importing or exporting. Drum kits as shown in the **Drum Kit Browser** are simply a collection of drum kit related parameters stored in a table. These parameters define the sounds used, but don't store entire sound sample libraries. Especially when exporting a drum kit, it is crucial

that the referenced sound samples are installed, whether they are factory sounds or sounds downloaded from the **Sound Store**. Missing sounds in the importing device will result in empty **Sound Select** fields in **Kit Editor** → **Module 2** → **Instrument Select**.

Drum Kit Parameters -Performance			
Mode	Parameter Values	Direct (Custom)	Preset (Indirect)
 Performance			
	Snare Style – all related parameters	•	
	Mixer – Volume Faders	•	
 Hint	Any change in value of one or more of the parameters shown above will cause the drum kit name to update. A preceding asterisk (*) will be added to the drum kit name in all Drum Kit fields in the user interface. The asterisk is a reminder to save the drum kit before changing it, so that altered kit parameters are retained.		
	Instances of the Drum Kit field are in: Performance → Module 1 → Drum Kit Kit Editor → Module 2 → Drum Kit		
Example			

For details on drum kit parameters, please refer to the **Kit Editor** section on page 37. The most relevant task in **Performance** mode is being able to select a drum kit.

8.2 MODULE 2

In this module you can monitor your trigger detection, customize the behavior of the snare rim and mix all pad volumes in relation to each other.

8.2.1 KIT OPTIONS

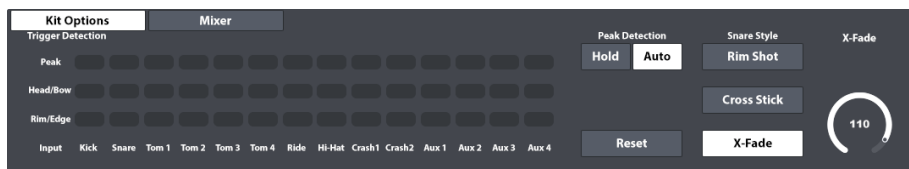

8.2.1.1 TRIGGER DETECTION

The Trigger Detection panel allows for monitoring general trigger settings for each individual Pad (Input Channel) inside the Performance mode. You can't change trigger settings in this view, but you will be provided with visual feedback about the trigger performance. Red color lighting up while playing moderately or softly is an indicator that a pad is maxing out too quickly and trigger settings should be reviewed. (For more information see section 11 Trigger Settings on page 77)

How it works:

For each input channel, detected MIDI velocity values are returned as values of a color scale from (0) to (127). The actual color values might vary depending on the chosen UI Theme. Deviations from the normal color scheme only occur regarding different types of color blindness. The regular appearance of gradients is then replaced by a scheme out of the perceivable color spectrum of the concerned group of people. See the table below for color scales by UI Theme.



- **Peak:**
Lights up only when maximum velocity values are reached in either Head/Bow or Rim/Edge (Values of 126 and 127).
- **Head/Bow:**
Provides real time feedback about Head and Bow values within the normal range of 0 to 125.
- **Rim/Edge:**
Provides real time feedback about Rim and Edge values within the normal range of 0 to 125.

Color Scales for Peak Detection by UI Theme			
	UI Theme		
MIDI Velocity Value	GEWA Red GEWA Classic GEWA White Tritanopia	Protanopia Deuteranopia	Grayscale
Peak (126-127)			
Normal High (125)			
Normal Low (1)			

8.2.1.2 PEAK DETECTION

The functions filed under **Peak Detection** comprise all options for customizing the behavior of the **Trigger Detection** field.

- **Hold:**
The trigger detection panel updates and stores its visual feedback until resetting the view manually.
- **Auto:**
The trigger detection panel is reset automatically after a time-out of approximately 3 seconds after the last input signal detected.
- **Reset:**
Tapping refreshes the values in the **Trigger Detection** field.

8.2.1.3 SNARE STYLE (RIMSHOT, CROSSTICK AND X-FADE)

Here you can quickly set the rim sound, to either **Rimshot**, **Crosstick** or **X-Fade**. X-fade is a dynamically driven switch which returns either rimshot or cross stick depending on the velocity of the stroke. If you select x-fade, the dial of the same name activates and enables you to adjust the threshold for the dynamics of the cross stick before it turns into a rimshot. Tap on the **[X-Fade dial]** to activate the fader. Note that the higher the fader position, the harder you must strike the rim to trigger a rim shot.

8.2.2 MIXER

Another option is to change the volume coming from any given pad in relation to the other pads. Simply tap on the **[Mixer]** button next to the **Kit Options** button and then change the pad volumes as desired. Another useful function is grouping toms or cymbals. This function allows for changing toms and cymbals all at once in fixed relation to each other. **Double tap on a fader to restore its default factory position.** Grouped faders will center to the fader tapped, preserving their spacing. Leave the mixer by tapping on **[Kit Options]**.

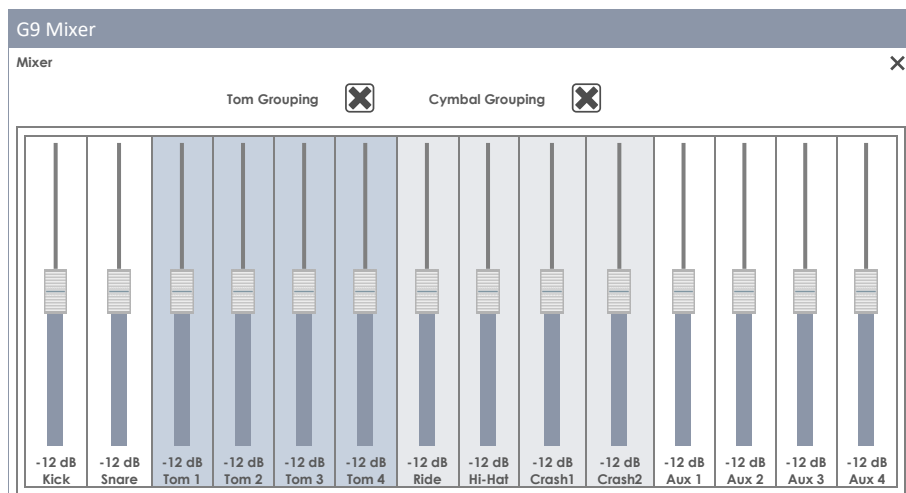

Note, that **Snare Style** and the **Mixer Volume Faders** are parameters stored in the drum kit, whereas fader grouping is stored in the default device data bank. A detailed description of drum kit parameters is topic of the **Kit Editor** mode (see section 9.2.1.5 *Drum Kit Presets - Parameters on page 44*).

8.3 MODULE 3

8.3.1 SONG PLAYER

The **Song Player** lets you play along to backing tracks and helps mastering difficult parts of songs while practicing. It utilizes the **File Select** browser to load all common audio file formats such as **mp3**, **wav**, **m4a** and **flac**.



Song Player – Supported File Formats

Icon	Ext.	Description	Developer
	*.aif	Audio Interchange File	Apple Inc
	*.flac	Free Lossless Audio Codec	Xiph.Org Foundation
	*.m4a	MPEG 4 Audio	International Organization for Standardization (ISO)
	*.mp3	MPEG Layer III	Moving Picture Experts Group
	*.ogg	Developers' Project Name	Xiph.Org Foundation
	*.wav	Waveform Audio File	Microsoft & IBM
	*.wma	Windows Media Audio	Microsoft

8.3.1.1 FILE SELECT BROWSER

The File Select browser is implemented in various applications in the G9, such as the **Song Player**, **PDF Reader** or **Import Tool**. However, depending on the application, it opens with different filters active to only show relevant file types. Regarding the **Song Player**, it displays all relevant audio files only. Consequently, non-interpretable files are hidden and grayed out.

8.3.1.1.1 PROPERTIES

The top-left side hosts buttons for **selecting storage mediums**, as well as the **search function**, which can be utilized as an alternative to linear path navigation. All these buttons are activated by a **single tap**.

G9 File Select Browser - Source Selection and Search



Navigation – Up the path



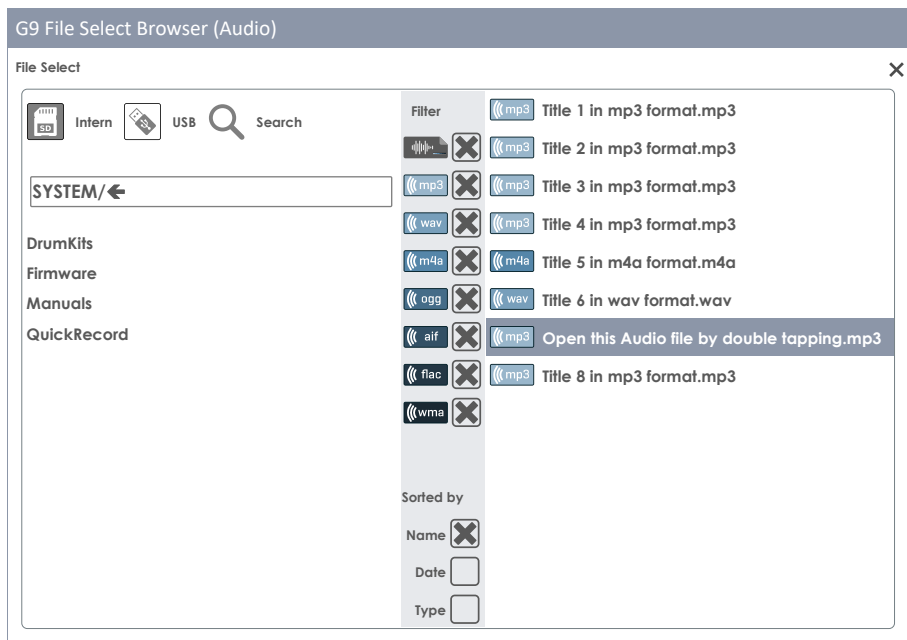

The **left column** displays all **folders** in the open directory, the **right column** lists all contained **files**. Double tap on a folder name to open it moving down the directory path. Tap on the **[white bar]** below the **[SD]** and **[USB]** buttons to move up the path by one node each tap. The **panel in the middle** contains **filter** options and **sorting functions**. Check the boxes as desired to display contents the way you prefer.

8.3.1.1.2 OPEN AUDIO FILES

In **Song Player**, proceed as follows:

1. Tap the **[File field]** in the top-left corner to open **File Select**.

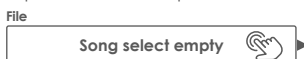

2. Specify the storage medium by tapping once on **[USB]** or **[SD]**.



3. Navigate to your file
 - a. Double tap on folder names to open them (left column).
 - b. Move up the path by tapping the **[white bar]** (left column).







4. Select a file to open by double tapping list entries in the right column.

8.3.1.2 SONG PLAYER FEATURES

With an audio file loaded you have access to a selected palette of functions that are designed to accompany songs with the instrument as well as improving your practice routine.

The main player buttons are shown in the following table:

Basic Player Functions	
	Play/Pause
	Stop
	Skip Forward
	Skip Backwards
	Play/Stop (On Stage Mode)

State dependency when loading an audio file:

Whether a song starts directly after its selection depends on the state of the **Play/Pause** and **Stop** buttons. the next selected song will start automatically if a song is already playing. In case of **Pause** and **Stop**, the selected file will be loaded into the player, but only starts by tapping **[Play]** manually. This property provides full control while practicing or being on stage (manual start in paused or stopped state), and quick file changes in the playing state let the song player act as an ordinary audio player.

Skip Buttons:

The behavior of skip buttons depends on the selected **Play Mode** as well as the state of **Play/ Pause** and **Stop** buttons.

- **Play Once or Loop Song** active:
The song either starts from the beginning (Play) or the timeline is reset to zero and the song starts at the beginning after tapping **[Play]** manually (Paused or stopped song).
- **Loop Folder** selected:
The player skips between all songs in the folder. Sorting settings made in the file select browser apply.

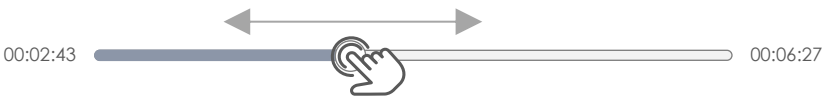

8.3.1.2.1 TIMELINE

With a song playing or being stopped/paused, you can tap and drag the moving dot in the timeline to jump to a passage of interest. Alternatively, pressing down on any point on the timeline will move the dot to the area of applied pressure. Both methods work in every player state (play, pause, stop).



8.3.1.2.2 PLAY MODES

The Song Player offers three different **Play Modes**:

Play Modes	
	Play once
	Loop active song
	Loop folder

To select a play mode, tap once on the corresponding icon.



8.3.1.2.3 EXTERNAL SONG PLAYERS

Other options for choosing songs are by connecting your phone with either **Bluetooth** or the **MIX IN** port in the back of the console. In this case the loop function is not available, and you use the control functions of the external player instead. How to connect an external device via Bluetooth with the G9 is described in section 12.4.3 Bluetooth (Page 129).

8.3.1.2.4 LOOP



Loop a certain part of a song by tapping **[Loop]** at the start and end points. Increase precision by taking advantage of the **Vari Speed** function and slow down the song tempo beforehand. (see section 8.3.1.2.6 *Vari Speed* on page 32)

Loop	
	Loop section (Tap 2 times to set start and end markers)
	Visual feedback loop (start- and endpoints)

8.3.1.2.5 QUICK RECORD



Quick record allows you to record all inputs, including song and drum kit and store it on the internal memory or any USB device. Tap on the **[Quick Record]** button once to start recording. Another tap will stop the recording and automatically store a file in the system folder "Quick Record" on the internal SD Card. Several Recordings are named in consecutive order. The standard file format is wav. Here is an example of a standard quick record file:

- **Quick_Record-00001.wav**

The default directory for quick record files is a system folder on the internal SD card. The directory path is:

- **INTERNAL SD/SYSTEM/Quick Record**

Use the **File Manager** to locate the QuickRecord Folder and rename, move or delete your recordings. Go to **Tools** → **File Manager**. (see section 13.3 *File Manager* on page 145)

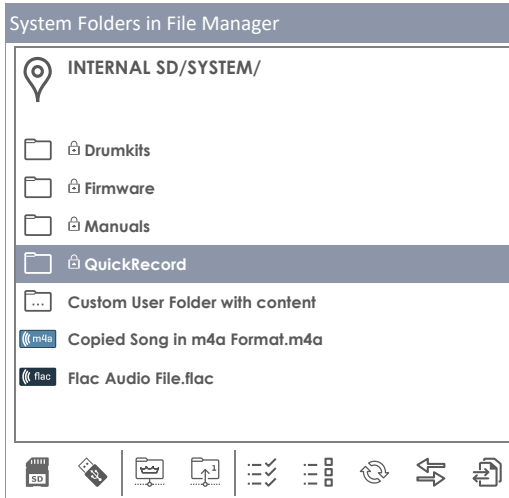

8.3.1.2.6 VARI SPEED

The Tempo of the song playing can be altered by using the **Vari Speed** function. Tap once on the **[Vari Speed]** dial and adjust the speed by dragging the fader up or down. The slider allows for speeding up or slowing down by 50% compared to the recorded tempo. Note that even if the speed varies, the pitch remains the same.

8.3.1.2.7 SONG VOLUME

Adjusts the volume of the Song Player relative to all other inputs.





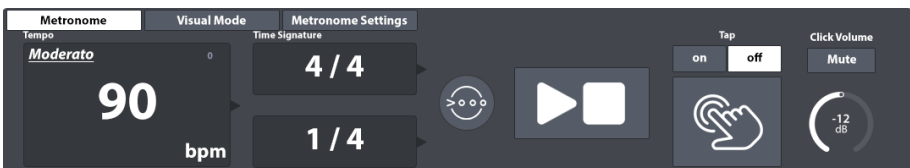



8.4 MODULE 4

8.4.1 METRONOME

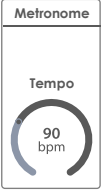
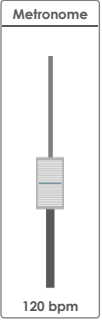
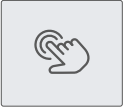

Set the **Metronome Tempo** by doing one of the following:

- Turn the physical dial at the top.
- Tap the software dial once and drag the fader.
- Tap once on the **Tempo Field** and set the metronome via the number pad that pops up.
- Tapping the **[Tap]** button periodically to set the tempo organically (Switch Tap on),
- Specify a custom tap channel parallel to the **[Tap]** button.

Adjusting the Metronome Tempo				
<p>Number Pad</p> 	<p>Hardware Dial</p> 	<p>Software Dial</p> 	<p>Fader</p> 	<p>Tap Button</p> 
Gestures				
<p>Tap</p> 	<p>Turn</p> 	<p>Tap</p> 	<p>Drag</p> 	<p>Tap</p> 

Buttons Metronome	
	Tap periodically to set tempo
	Start/Stop

You can also control the **Time Signature**, the **Interval** and the **Click Volume**. Tap once on the respective field to call up the option wheels and faders. A **[Mute]** button turns off the metronome sound without changing settings made in module 4.

 The **Accent One** button accents the first beat of the active time signature. By default, this feature is turned on. Turn it off for an even stream of the click without any accents.

8.4.2 VISUAL MODE

There is also an option for a **Visual Mode** where numbers will appear and light up with the speed of the metronome. Tap on the button **[Visual Mode]** next to the function set **Metronome**. A Pop up appears which covers module 3, leaving full access to all metronome settings which affect the visual mode. To see all effects of your adjustments in the following, please activate the **[Play]** button first.

To change the appearance of the visual mode you have 2 options:

- Change the **Time Signature** along the lines described in the previous section and observe how the content of the visual mode changes.
- Click **[Mute]** or **[Unmute]** to deactivate or activate the click sound.



- i** **Tip:** The visual mode is designed to be vertically free floating. Place a finger the top of the pop-up, hold down, and drag the box up or down into its desired position. It is the only pop-up that won't close automatically when leaving the performance mode. As a practice tool it is considered to always stay in front. You can only close it manually by tapping on **[x]** in the upper right-hand corner.

8.4.3 METRONOME SETTINGS

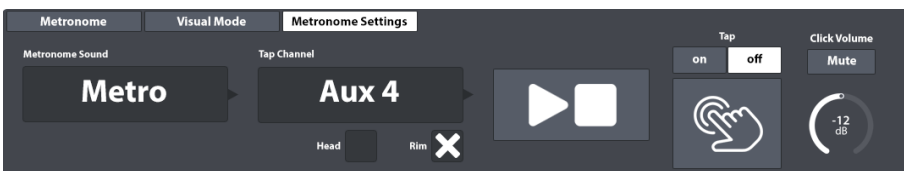

In this function set you can customize the **Metronome Sound** as well as the channel for setting the metronome speed by playing (**Tap Channel**).

8.4.3.1 METRONOME SOUND

The metronome sound by default is "Metro". However, this can be changed easily:

1. Tap once on the **[Metronome Sound]** field.



2. (Optional) Preview metronome sounds:
 - a. Activate the **[Play]** button (make sure **Click Volume** is not muted).
 - b. Tap once on a sound (Metro, Claves etc.).
3. Select a sound by doing one of the following:
 - a. Select the preferred sound by double tapping.
 - b. Keep the currently selected sound by tapping on **[x]** in the upper right-hand corner. This closes the dialog.

8.4.3.2 TAP CHANNEL

You can also select a custom tap channel instead of using the **[Tap]** button. This function can be found under the function set **Metronome Settings**. To choose a custom tap device, proceed as follows:

1. Touch the field [**Tap Channel**].



2. Select a pad from the drop down by double tapping.
3. Specify the desired pad component by checking one or both boxes below the **Tap Channel** field (Pad or Rim etc.).

All functions on the right-hand side of the **Tap Channel** field are identical with those in the function set **Metronome**. Thus, make sure that **Tap** is set to "on" and **Click Volume** is not muted.

9 KIT EDITOR

In the Kit Editor mode, you can modify the current drum kit presets, such as changing the individual pad sounds, tuning of drums and adding effects. Furthermore, it is possible to add equalization and compressors to the sound of each pad. Instead of changing all the pads together with the **Drum Kit** selector, you can customize each pad to the desired sound qualities. Use the presets provided as a starting point. Finally, you will learn how to save, export and import drum kits of the drum kit library.



All settings made in the Kit Editor mode apply to the active Drum Kit, which is shown in the respective **Drum Kit** fields.



9.1 MODULE 1

9.1.1 CHANNEL SELECT

The main purpose of the channel select feature is to select connected pads for reasons of assigning different sounds (Kit Editor) or editing their trigger parameters (Trigger Settings).

9.1.1.1 INPUT CHANNELS

The Pad order from left to right matches the order of **Trigger Inputs** of the rear panel.

Select a connected pad by tapping the file above the pad name. A selected pad is highlighted by a surrounding frame.

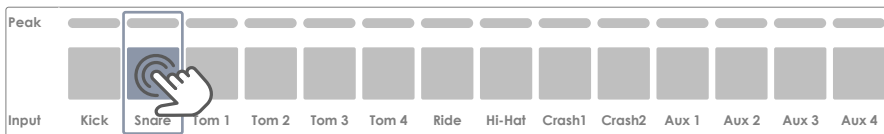

G9 Ports – Input Channels



The **Peak** row remembers the highest Velocity value detected for each pad. It works in the same way as the peak rows available in other modules and returns the **maximum velocity across all pad components**. Consequently, you are informed about a pad issue if you constantly spot the peak color while playing. The deeper analysis, however, must follow in **Trigger Settings** mode using the **Pad Monitor** (module 4).

In the **Peak** row the velocity scale of 0-127 is translated into color values which depend on the selected UI Theme. Check your UI Theme first to be able to interpret the colors returned under Peak. (see **General Settings** → **Module 4** → **Device** → **UI Theme**)

The following table shows the relation between velocity value, UI theme and color gradients used:

Color Scales for Peak Detection by UI Theme

	UI Theme		
MIDI Velocity Value	GEWA Red GEWA Classic GEWA White Tritanopia	Protanopia Deuteranopia	Grayscale
Peak (126-127)			
Normal High (125)			
Normal Low (1)			

9.1.1.2 AUTO SELECT

With Auto Select it is possible to select an input channel by playing the connected pad on one of its components. Turning this feature **[on]** will add the play-to-select feature to the standard select-by-tapping function on the screen. It is recommended to use this feature sparingly, since it can cause confusion when touching other pads accidentally.

9.1.1.3 PEAK DETECTION

With this function you can reset the peak monitor of the active module to the color value assigned to the velocity level of 0. This is especially important to check if altered trigger parameters work as desired. Tapping **[Reset]** refreshes the Peak Monitor and deletes the detection history.

9.2 MODULE 2

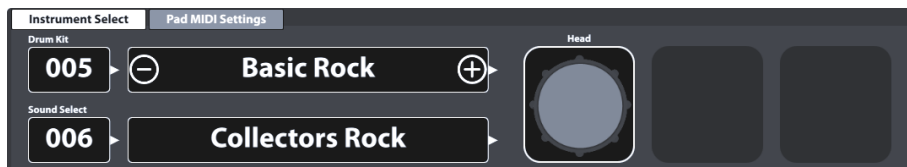

9.2.1 INSTRUMENT SELECT

9.2.1.1 DRUM KIT

The Drum Kit field is the starting point for any activity regarding sound design and trigger settings. All adjustments made in these modes apply to the selected drum kit. The **Drum Kit field** in **Kit Editor** mode is an instance of the **Drum Kit field** in **Performance** mode, so that they both update simultaneously when managing Drum Kits in one of them.

To select a drum kit in Kit Editor the following options are available:

- Tap the **[Drum Kit name]** field to open the **Drum Kit Browser**.
- Tap **[+]** or **[-]** in the **[Drum Kit name]** field to cycle through the drum kit library.
- Tap the **[Drum Kit number]** field to enter the desired kit number via the **Number Pad**.

The **Drum Kit Browser** is explained in detail in the section **Performance mode** (*See 8.1.1.1 Managing Drum Kits (Presets) on page 24*). In Kit Editor, we will focus on preset management utilizing the functionalities of its Feature Shelf.

9.2.1.2 PAD COMPONENTS

The pad component icons are located on the right-hand side of module 2. You can tap on an icon to activate the component, giving access to its parameters in module 3. The appearance of the icons and their naming depends on the **Trigger Bank** assigned. Assigning a cymbal trigger bank will display Bow/Bell/Edge icons and cymbal parameters in module 3, even though the corresponding input channel is labeled as e.g. Snare. This means in most cases you can convert a pad input channel to a cymbal input and vice versa. However, not all components of the trigger bank might be accessible due to a different hardware design of the channel on the trigger board.

When gaining an understanding of the G9 Kit Editor, it is important to point out that all function sets and parameters of module 3 and 4 always refer to the selected pad under **Input Channels** and its active **Component** (component icon in module 2). The sound assigned to a component is shown in the **[Sound Select]** field. Sound name and component icon frames use the same **color values**, giving a quick visual feedback about which component is active. By changing either pad or component, sounds (module 2) and parameter values (module 3) will update accordingly.

To keep track of your sound settings, try to look at this mode as a cascade of Input Channel, Component, Sound and Parameters:

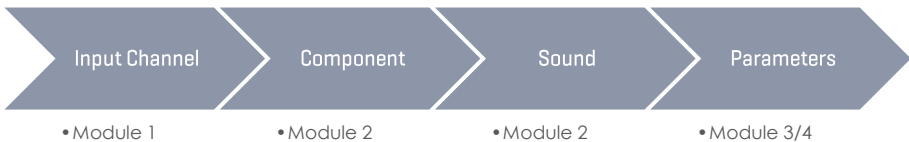
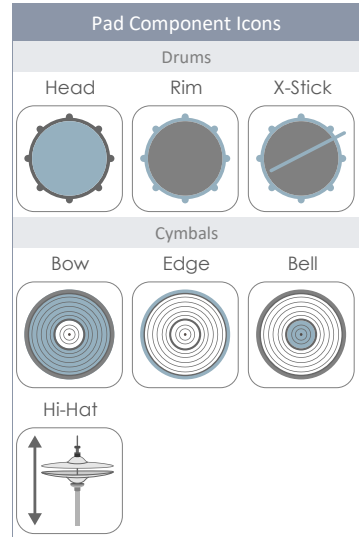

Every edit of sounds should follow the order shown above.

9.2.1.3 SOUND SELECT

The **Sound Select** field displays the sound assigned to the active pad component of the active pad (Input Channel). Sound names are highlighted in the color of the active component tile to help the understanding of the connection between icon and sound name visible.



With the correct component selected, tap the **[Sound Select name]** field to open the **Sound Browser** and select a new sound from the sound library by double tapping on a list entry.

9.2.1.4 SOUND BROWSER – PROPERTIES

The sound browser lists all installed sounds by instrument categories, which are represented by the tabs shown on top of each sound list. By default, list entries are sorted by ascending internal sound numbers of the active instrument category (tab). This ordering can be changed by checking one of the options available under “Sorted by”.

The alternative ordering options are:

- Instrument Name
- Category → Cat = **AC** (Acoustic), **EL** (Electronic), **PR** (Processed) or **FX** (Sound Effects)

Tabs and contents below the sorting options vary depending on the selected **Source**. The **Sound Browser** separates installed factory sounds (**Internal**) from imported user sounds (**Import**). Check the corresponding box to follow the specialties of each source in the next sections.

9.2.1.4.1 SOURCE – INTERNAL

Activating the **Internal** check box under **Source** will display the following instrument sound categories (tabs):

Sound Categories (Source = Internal)				
Kick Drums	Snare Drums	Toms	Ride Cymbals	Crash Cymbals
Hi-Hats	Cymbals SFX	Percussion 1	Percussion 2	Sounds SFX

Tap one of the category names to browse the contained sounds.

9.2.1.4.2 SOURCE – IMPORT

Activating the **Import** check box under **Source** will display all sounds imported via the **Import Tool** (See 13.5 *Import Tool* on page 158). The Tab “**Wave**” contains all imported **single layer wave samples** (created by users), whereas all other tabs contain imported **multi-layer sound banks** downloaded from the **GEWA Cloud**. Sounds downloaded from the **Cloud** will be filed under the correct Instrument category automatically during the import (See 13.6 *Shop* on page 163).

Sound Categories (Source = Import)				
Kick Drums	Snare Drums	Toms	Ride Cymbals	Crash Cymbals
Hi-Hats	Cymbals SFX	Percussion 1	Percussion 2	Wave

Tap one of the category names to browse the contained sounds.

9.2.1.4.3 ASSIGNING SOUNDS – SOUND GROUPING

The assignment of sounds via the sound browser is straight forward (**double tap a list entry**). However, there are some features built into the **File Browser** that allow for **batch assignment** to all components at the same time. The main feature is called **Sound Grouping**.

With sound grouping the user can pick all matching component sample sets of a recorded instrument at the same time and assign it to an input channel, regardless which component icon is active.

How it works:

In the **Sound Browser** list entry names end with a suffix indicating the type of component sample.

Regarding **cymbal samples** Suffix and component name are identical and selecting one component sample will select all other matching sample sets automatically.

Drums use the feature **positional sensing**, which detects the position of the stick on the head and blends samples from the side of the head (rich overtones) with focused samples from the center. To this end **head sounds** are further divided into sample sets to be used in conjunction with positional sensing.

- Center-Side Blend (CS)

and sample sets that only consist of samples from one of the 2 zones:

- Center Only (C)
- Side Only (S)

The choice of one of the latter de facto deactivates positional sensing by returning sounds of the same zone, no matter which position on the head is detected.

Sound Grouping is designed to quickly pick all relevant samples that create the most realistic digital footprint of the entire sampled instrument. This means that it requires the **CS** samples for heads. Consequently, selecting Rimshot or X-Stick samples with **Sound Grouping on** will automatically select the matching **CS** version of the head samples. Starting with the head on the other hand will require to select a CS sample set to automatically select the corresponding Rimshot and X-Stick samples in the entry list of the **Sound Browser**. When assigning C or S head samples, sound grouping is ignored, and the chosen sample will only affect the active component.

G9 Sound Browser

Sound Browser ✕

Sorted by

Instrument Category

Kick Drums	Snare Drums	Toms	Ride Cymbals	Crash Cymbals
Hi-Hats	Cymbals SFX	Percussion 1	Percussion 2	Sounds SFX

Number	Instrument	Cat
001	14" Collectors Maple C	AC
002	14" Collectors Maple S	AC
003	14" Collectors Maple CS	AC
004	14" Collectors Maple Rim	AC
005	14" Collectors Maple X-Stick	AC
006	14" US Vintage C	AC
007	14" US Vintage S	AC
008	14" US Vintage CS	AC
009	14" US Vintage Rim	AC
010	14" US Vintage X-Stick	AC
011	Broadkaster VBE CS	AC

Source

Internal

Import

Sound Grouping

The following table sums up the relationship between **Sound Grouping** and list entries of the **Sound Browser**:

Multi-Layered Samples - Drums					
Component	Head			Rim	
Sample Set	Center	Side	Center/Side Blended	Rimshot	X-Stick
Suffix	C	S	CS	Rimshot	X-Stick
Sound Grouping	No	No	Yes	Yes	Yes

i **Tip:** Access the Sound Browser directly by holding down your finger on a component icon for 1 second. Note that you only modify the component selected when Sound Grouping is unchecked. With Sound Grouping checked you assign a full set affecting each component, regardless by which component icon you have accessed the Sound Browser.

i **Hint:** If icons and their names don't match the pad (cymbal or drum) you want to edit, then check the trigger settings first. It is likely that the trigger bank assigned to the Input Channel is not correct. The trigger bank assigned to a pad determines the icons shown in the function set Instrument Select. Go to **Trigger Settings** → **Module 2** → **Trigger Selection** → **Trigger Bank** and tap on the **[Trigger Bank]** field to assign a matching Trigger Bank for the active Input Channel. As a result, all component icons under **Kit Editor** → **Module 2** → **Instrument Select** should update accordingly.





Every assignment made using the **Sound Browser** changes the parameter values of the active Drum Kit. To keep these changes, it is necessary to save the Drum Kit preset using the Drum Browser. This is the topic of the next section.

9.2.1.5 DRUM KIT PRESETS - PARAMETERS

Drum Kit Presets store values of all parameters associated with a recorded drum set. In the G9 interface, accessible drum kit parameters are spread over several thematically divided modes: **Performance**, **Kit Editor** and **Effects**. Every change in one of the relevant parameters will potentially require saving the active drum kit or creating a new one using the **Drum Kit Browser**, otherwise edits will be discarded as soon as you change the kit. Since the kit editor mode hosts most of the relevant drum kit parameters, we will have a closer look at parameters and preset management in this section.

Before we start, it is important to understand that drum kits listed in the **Drum Kit Browser** are simply a collection of drum kit related **parameter values stored in a table**. These parameters define the sounds used, but **don't store entire sound sample libraries**. Especially when exporting a drum kit, it is important that the referenced sound samples are installed on the importing device, whether they are factory sounds or sounds downloaded from the **Sound Store**. Missing sounds in the importing device will result in empty **Sound Select** fields in **Kit Editor** ➔ **Module 2** ➔ **Instrument Select**.

The following table shows all drum kit parameters across the different modes of the G9:

Drum Kit Parameters -Complete List			
Mode	Parameter Values	Direct (Custom)	Preset (Indirect)
 Performance			
	Snare Style – all related parameters	•	
	Mixer – Volume Faders	•	
 Kit Editor			
	All sound referencing per channel	•	
	Pad Midi Settings	•	
	All Mix/ Effect Sends parameters	•	
	All Sound Edit parameters	•	
	All Second Sound parameters	•	
	All Hi-Hat Volume parameters	•	
	Pad EQ - On/Off Switch	•	
	Pad EQ - All curve parameters	•	•
	Pad Compressor- On/Off switch	•	
	All Compressor parameters	•	•
 Effects			
	On/Off Switch expression	•	
	FX Send Level Faders	•	
	Level	•	
	Pre-Delay (Ambience)	•	
	Gate Threshold (Instrument Reverb)	•	
	Send to Room Reverb (Multi FX)	•	
	Every other FX 2-4 parameter ...	•	•
 Hint	<p>Any change in value of one or more of the parameters shown above will cause the drum kit name to update. A preceding asterisk (*) will be added to the drum kit name in all Drum Kit fields in the user interface. The asterisk is a reminder to save the drum kit before changing it, so that altered kit parameters are retained.</p> <p>Instances of the Drum Kit field are in: Performance → Module 1 → Drum Kit Kit Editor → Module 2 → Drum Kit</p>		
Example			

All relevant drum kit parameters of the Kit Editor can be found in modules 3 and 4 including the sound referencing of the **Sound Select** field (module 2).

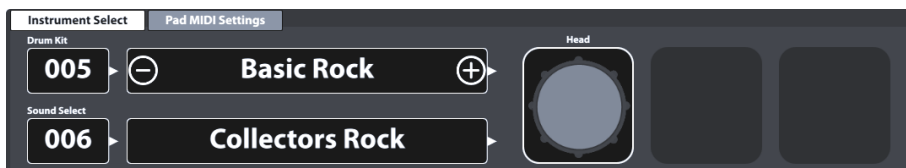

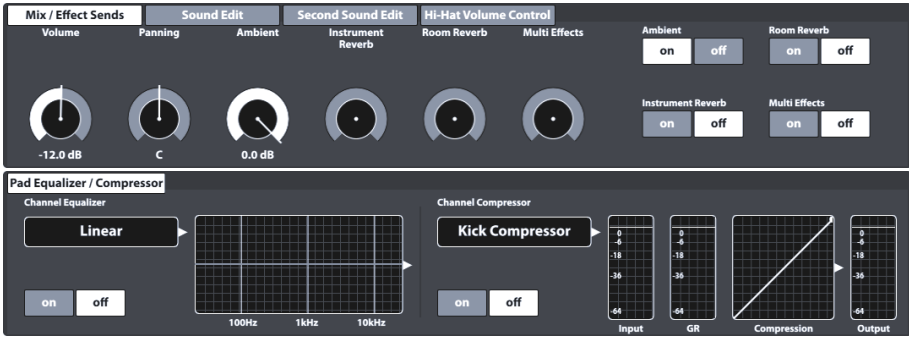

A detailed explanation of each parameter will follow in the respective modes. The following sub section assumes parameter values to be set and tackles the preset management of Drum kits such as the creation of new kits or the exchange of drum kit presets between different G9 devices.







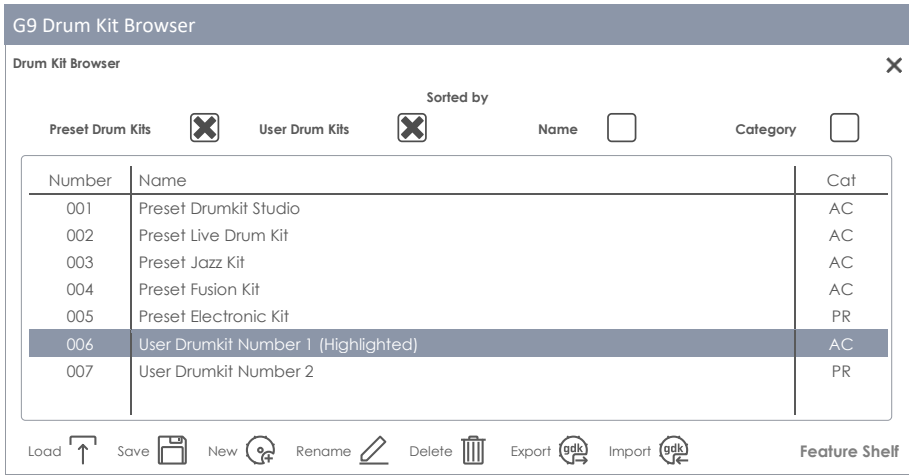
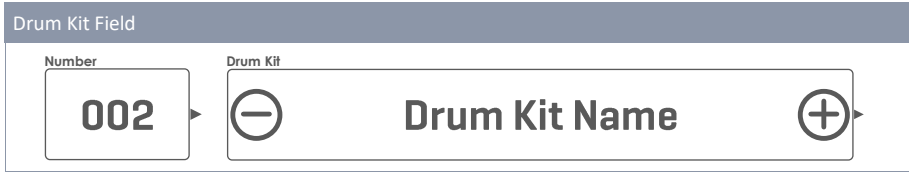



9.2.1.6 PRESET MANAGEMENT - ELEMENTS

The parameters presented above form a Drum Kit preset, which can be saved as an individual user Drum kit. The G9 provides a variety of features to handle these presets. All these functions can be found in the **Drum Kit Browser** which is explained in detail in the Performance mode section of this documentation. The **Drum Kit Browser** can be accessed by tapping the **[Drum Kit]** field, which has an instance in Performance and **Kit Editor** mode. The relevant UI locations are:

- Performance → Module 1 → Drum Kit
- Kit Editor → Module 2 → Drum Kit



The bottom section of the Drum Kit Browser hosts the **Feature Shelf** which contains all preset management options. The number of options varies depending on the type of preset. The G9 distinguishes between **user presets** and **factory presets**. Factory presets cannot be edited or deleted; therefore, the palette of options is restricted. See the following table for comparison:

Preset Management – Drum Kit Browser							
Category	Function						
	Load	Save	Rename	New	Delete	Export	Import
Factory Preset							
User Preset							

The process of managing drum kits is the same for all features available. It starts by tapping the **Drum Kit name field**, followed by a selection of the kit in the **Drum Kit Browser** and ends with the choice of the function in the **Feature Shelf**. See the following sections for particularities of the individual functions.

9.2.1.6.1 LOADING DRUM KITS

Proceed as follows:

1. Tap the **[Drum Kit]** field to open the **Drum Kit Browser**.
2. Do one of the following:
 - a. Highlight a Drum Kit in the list by tapping once and tap **[Load]** in the Feature Shelf.
 - b. Double tap a list entry to load the Kit.

After step 2 the drum kit browser closes automatically, and the selected kit is active. The drum kit name in the drum kit field will update accordingly.

9.2.1.6.2 SAVING AND OVERWRITING DRUM KITS

In preparation please check if the **Drum Kit name** in the **Drum Kit field** is preceded by an **asterisk (*)**. Drum kits without asterisk do not possess any changed parameter values and consequently it is not necessary to save them. Saving or overwriting a drum kit will replace all stored drum kit parameter values by the values currently set in the UI (across all modes). With a visible asterisk proceed as follows:

1. Tap the **[Drum Kit]** field to open the **Drum Kit Browser**.
2. Determine whether you want to save the active kit, or whether you prefer to overwrite a different kit with the parameter values currently active in the Interface:
 - a. **Save** → Do nothing, the active kit is highlighted by default.
 - b. **Overwrite** → Highlight a Drum Kit in the list by tapping once.
3. Tap **[Save]** in the Feature Shelf.

After step 3 the drum kit browser closes automatically, and the parameter values of the drum kit selected in step 2 are overwritten by the current parameter values of the user interface.

9.2.1.6.3 RENAME DRUM KITS

Renaming a drum kit will affect the preset name only and retain individual parameter values. This option is not available for factory drum kits.

1. Tap the **[Drum Kit]** name field.
2. Tap once on a user drum kit in the drop-down list.
3. Tap **[Rename]** in the Feature Shelf.
4. Enter a new name for the preset using the keyboard.
5. Confirm by tapping **[OK]**.

9.2.1.6.4 DELETING DRUM KITS

Proceed as follows:



1. Tap the **[Drum Kit]** name field.
2. Tap once on a preset name in the drop-down list.
3. Tap **[Delete]** in the Feature Shelf.

9.2.1.7 DRUM KIT EXCHANGE

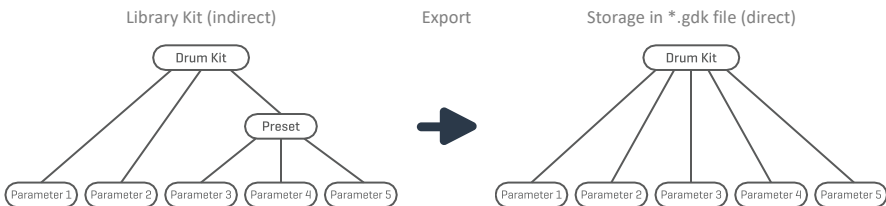
With drum kit exchange the G9 allows for exporting drum kits to create backup files of favorite kits including effects. This feature is hosted in the feature shelf of the **Drum Kit Browser** and allows for sharing your drum kits with other G9 devices via the built-in import feature. The relevant file format is **gdk** (GEWA Drum Kit) which is recognized in the file browsers of the user interface by its own icon. When exporting a drum kit, all presets are discarded, and parameter values are stored directly instead, resulting in **"Custom Setting"** contents of any preset field of the relevant drum kit parameters. This means that if presets are preferred you must store each preset individually after the import, or simply assign the underlying presets from your existing preset library again and save the kit.



Also, be aware, that a gdk file does not store any sound samples, but just the relevant drum kit parameters including sound referencing. A gdk file requires addressed samples to be installed in the sound library as either **factory sound** or imported sound from the **GEWA Sound Store**. In case of sounds not being installed on the target device, an import will result in empty **Sound Select** fields (Kit Editor) and the Pads won't be audible. (See also 13.6 Shop on page 163 and 13.5 Import Tool on page 158)

Drum Kit Exchange	
	gdk – GEWA Drum Kit File
	Drum Kit Export
	Drum Kit Import

The following sections guide you through the processes of drum kit export and import.

9.2.1.7.1 EXPORT

The export of a drum kit is straight forward. Tapping the **[Export]** icon in the feature shelf will store a copy of the drum kit in the default export folder on the internal SD Card. The corresponding directory path is:

INTERNAL SD/SYSTEM/DrumKits

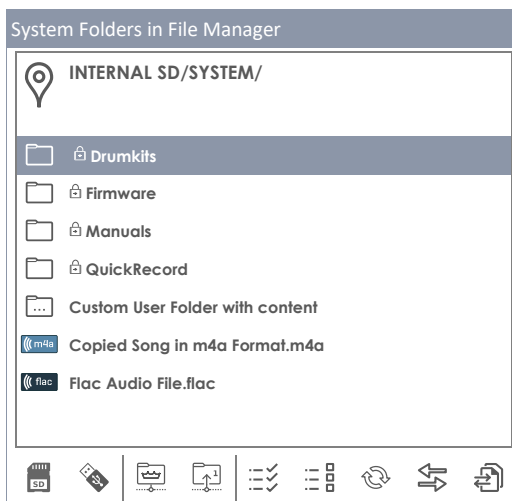

Use the **File Manager** to copy the exported drum kit on a USB stick for import in other G9 devices (See 13.3 File Manager on page 145).

To export a drumkit in gk file format proceed as follows:

1. Tap the **[Drum Kit]** name field to open the **Drum Kit Browser**.
2. Highlight the drum kit to be exported in the drop- down list (tap once).
3. Tap **[Export]** in the **Feature Shelf**.

A success message appears, and the drum kit is stored in the default drum kit folder.

i Tip: Tap the **[Import]** button in the feature shelf to verify the successful export. The import browser by default opens the standard export directory (DrumKits).



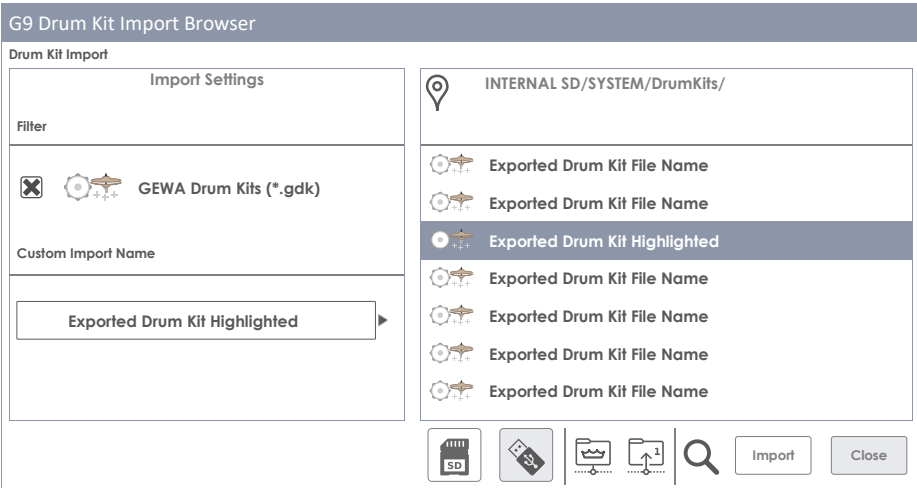

i Hint: A factory reset of the G9 will retain all data stored on the internal SD card. Your drum kit backups are protected.

9.2.1.7.2 IMPORT



The import is possible via USB or from the internal SD Card. In addition, it is possible to change the drum kit name stored in the *.gdk file. To import a drum kit, proceed as follows:

1. Tap the **[Drum Kit]** name field to open the **Drum kit Browser**.
2. Tap **[Import]** in the **Feature Shelf**.
3. Choose the storage medium where the file is stored (USB or SD).
4. Navigate to the drum kit to be imported using the browser on the right-hand side of the **Drum Kit Import** browser.
5. To select a file, choose one of the following options:
 - a. **Quick Import:**
 - i. Double tap the file to be imported. This will import the drum kit with the original export name. In case that the name already exists, the routine will add consecutive numbering.
 - b. **Custom Import** (rename option):
 - i. Highlight the file in the entry list (**tap once**). This will load the import name into the **Custom Import Name** field.
 - ii. Tap the **[Custom Import Name]** field to specify a custom import name using the keyboard.
 - iii. Confirm by tapping **[OK]** or tap **[Cancel]** to aboard.
 - iv. Tap **[Import]** in the bottom right corner of the **Task Bar**.
6. Tap **[Close]** in the bottom-right corner of **Drum Kit Import**.

Task Bar – Drum Kit Import	
	Internal SD Card (opens root directory)
	External USB device (opens root directory)
	Go to root directory of the active path.
	Move up one level in the folder hierarchy
	Search
Import	Imports highlighted Kit into the Drum Kit Browser.
Close	Closes the import dialogue (returns to Drum Kit Browser).

Characteristics using Search

Step 4 offers the option of using the search function as an alternative to the linear path navigation. To preserve the **Custom Import** option, it is not possible to directly import the drum kit from the search browser by double tapping. Selections made in the search dialogue will only load the chosen file into the field **[Custom Import Name]**. There are 2 alternative ways of loading the import file:

- Double tap an entry in list of search results.
- Highlight an entry in the list of search results (tap once) and tap the hook [✓] in the **Keyboard**.

For further information regarding search and navigation see sections [13.3 File Manager on page 145](#) and [13.4.1 Search on page 153](#).

File Name vs. Import Name

When exporting a drum kit, the import name and file name are identical. Renaming the file using **File Manager** or any other application will only change the file name. When importing a drum kit, the import name will be identical with the name of the drumkit originally exported, no matter if the file has been renamed. Highlighting a drum kit file in the **Drum Kit Import** browser will load the import name of the selected file into the **Custom Import Name** field.

9.2.2 PAD MIDI SETTINGS

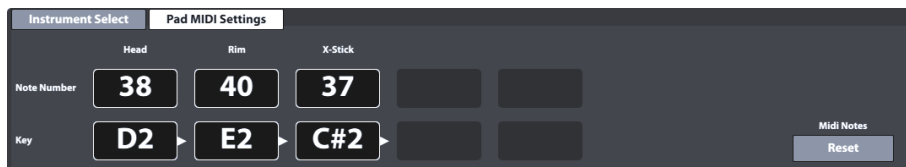

In this function set the user can set key values for **Midi OUT** configurations. **MIDI IN signals** regarding **trigger detection** of connected pads are fixed and can't be modified.

Tapping **[Reset]** in the right bottom corner will restore the factory configuration in which MIDI OUT assignments are configured equal to MIDI IN.

Settings made in this function set will affect both MIDI associated ports in the back of the console:

Ports – MIDI OUT



MIDI OUT (analog)



USB OUT (digital)

An example when a deviation from the internal key assignments of the G9 might be necessary is the fact that some manufacturers use a shifted key setup internally (e.g. assignment starts at a different octave of the keyboard). To make these devices compatible with each other, one then needs to change its external key assignment, otherwise the units would address other programs than the intended. Please refer to the MIDI implementation available for the devices you want to interact with and find out whether a change in key values is necessary.

9.3 MODULE 3

9.3.1 MIX / EFFECT SENDS



This function set controls the volume of the individual pad components and provides global controls to mix adjustments made in the **Effects** mode with the dry sound of the sample. You can also turn on and off each module of the Effects Mode. This way you don't have to switch to the **Effects Mode** to access important, global controls. Consequently, all edits in values of slider positions and switches must be stored in the active drum kit, otherwise they would be discarded when changing the drum kit.

9.3.1.1 VOLUME (COMPONENT)

This volume slider affects the volume of the currently active pad **component** in the **Instrument Select** function set in module 2 of this mode. Here you can adjust the volume of the pad components in relation to each other whereas the **Mixer** (see section 8.2.2 Mixer on p.27) globally raises or lowers the volume of this relationship.

9.3.1.2 PANNING (INPUT CHANNEL)

As opposed to the Volume, **Panning** affects the active pad in the function set **Channel Select** as a whole. As a result, you pan all components at the same time. This is useful to create a surround feel of your kit. The Low Tom for instance might have dominance on the right-hand side of the Speakers/Headphones, as it sits on the right-hand side of the acoustic drum kit. Thus, in your right ear it will be perceived louder than in the left ear. The Snare on the other hand is in the center of the kit and tends to a panning value of C (Center). If you have set up your kit like a left-handed player this holds true for the opposite side. Panning contributes to replicating the acoustic environment behind the drum kit – the player's perspective.

9.3.1.3 EFFECTS

The dials **Ambient**, **Instrument Reverb**, **Room Reverb** and **Multi Effects** allow for gradually dialing in settings made in the **Effects** mode. As an instance, these sliders are exact representations of the corresponding pad slider in the **FX Send** mixer of the **Effects** module. On the right-hand side, you can turn on or mute the corresponding module in the **Effects** mode. Tap on the corresponding software dial and increase the amount of an effect by dragging the slider up. When muting an effect in this function set, the dial values are saved (provided you don't change the Drum Kit before saving), so that they are remembered when turning on the effect again. The on/off buttons are an instance of the module switches in the **Effects** mode. When you turn off a module in **Effects**, you also mute it in the **Mix/Effect Sends** function set of the **Kit Editor** and vice versa. Effect dials don't distinguish between pad components but affect each component in the same way. For instance, it is not possible to assign a different ambience to a rim than to the matching head.

i **Tip:** All settings of this function set affect the currently active Input channel (pad) and/or its selected component as well as the active drum kit as a whole. Always be aware of the active drum kit, input channel and component, to keep track of your adjustments. Note that when changing the kit without saving, all adjustments are dismissed. Always save your work before moving on.

9.3.2 SOUND EDIT

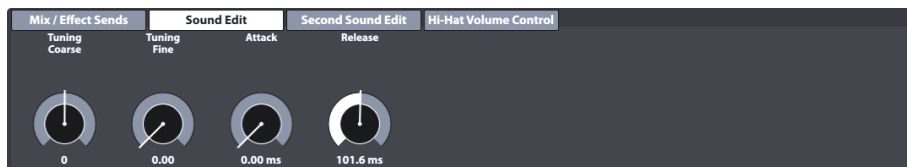

Although GEWA invested in multi-dimensional sampling of sounds, it is almost impossible to record any drum of any size and depth with any combination of differences in tension between top and resonant head. The number of required samples would be sheer endless and would exceed today's capacities of memory.

With this in mind, the function set **Sound Edit** offers tools to tweak the sound qualities of the recorded samples, such as changing the pitch and sustain of the drum. See all options below.

9.3.2.1 TUNING COARSE

This dial allows for rough tuning of the drum in **increments of semi tones**. With the default fader position in the middle of the spectrum you can tune up or down by 12 whole tones in each direction, giving you a full range of **24 whole tones (2 octaves)**. Tuning your sounds works on the **pad component** level, so that you can tune each component (e.g. Head or Rim) independently from each other.

9.3.2.2 TUNING FINE

From the chosen semi tone, you can fine tune the pitch. The default fader position is centered and has a full **range of one semi tone** (100 cents), allowing to tune up or down by a quarter tone (50 cents). The relative range of -50 to +50 cents is translated into fader scales from **0.00** (-50 cents) to **1.00** (+50 cents).

The following illustration shows how **Tuning Coarse** and **Tuning Fine** interlock giving full access to the full 2-octave spectrum in increments of one cent. Tuning up by 50 cents results in the same pitch as tuning down by 50 cents from the next higher semi tone:

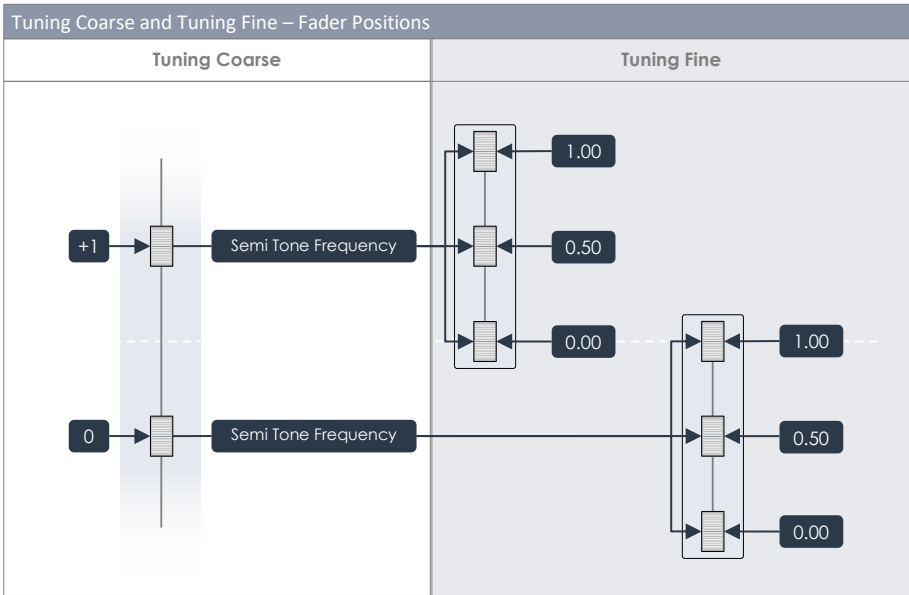

With the illustration in mind, the best practice for changing the pitch of the sound samples is consequently blocking out the rough pitch region with **Tuning Coarse** and fine tune it afterwards with the help of **Tuning Fine**.

9.3.2.3 ATTACK

Modify the attack of the drum by choosing a low fader position for tight and snappy feel and high fader positions for a “fluffy” feel with almost washed out attack.

9.3.2.4 RELEASE

Controls the length of sustain to emulate a muffled instrument. The natural sustain of the DRY sample (without effects) fades out quickly in low fader positions and slowly in high fader positions. Changing the fader position will add a predefined multiplier curve to the full sample amplitude, which is then moved inside the time interval of 15.5 ms – 6s after the attack by dragging the fader. The shape of the

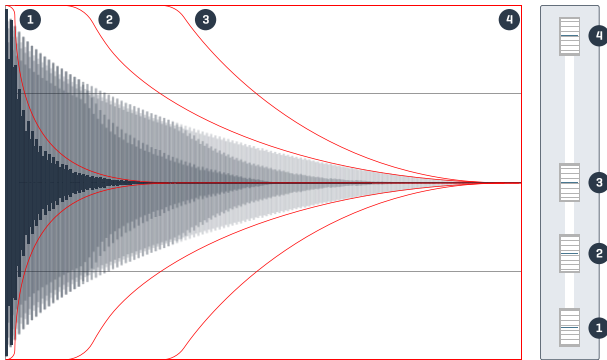

multiplier curve is a dynamic combination of a hold feature (multiplier = 1) and the tail with decreasing factors for longer time frames. This complex relationship is fixed and not editable in its parameters. The illustration above gives an idea, how the **Release** feature shapes the amplitude of a sample in relation to the fader position. Curves shown are optimized for visualization purposes and don't claim to be exact.

9.3.3 SECOND SOUND EDIT

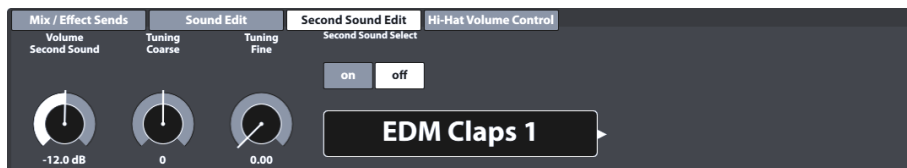

With Second Sound Edit you can layer a secondary sound on top of a pad component. An example would be layering tambourine jingles on top of a Hi-Hat to simulate a jingle ring mounted on the Hi-Hat rod. This option will affect the currently selected pad (check **Module 1** → **Input Channel**) and the active component in module 2 (Head, Rim etc.). All dials and options of this function set work in the same fashion as described in *Section 9.3.2 Sound Edit*. Once you are happy with the result, save the active drum kit before moving on.

9.3.3.1 VOLUME SECOND SOUND

While the volume of adjustments under **Sound Edit** is driven by the **Pad Mixer** (**Performance** → **Module 2** → **Mixer**), the layered second sound is driven by its own volume dial to adjust the volume in relation to the main sound of the component. The set relationship of the mix is then globally adjusted by the Mixer.

9.3.3.2 TUNING

This function set is equipped with the same functionalities for tuning as the function set **Sound Edit** (See 9.3.2.1 *Tuning Coarse* and 9.3.2.2 *Tuning Fine* on Page 53).

9.3.3.3 SECOND SOUND SELECT

Here, you determine the second sound sample to be assigned as well as its state when loading the drum kit (ON/OFF). That is to say that you can determine all qualities of the second sound and turn the second sound feature off before saving the kit, so that adjustments can be preconfigured and turned on quickly if desired. The **Second Sound Browser** contains all factory sounds. You can treat it as the **Sound Browser** with the difference that sound grouping and imported sounds are not available for layering (see also section 9.2.1.4 *Sound Browser – Properties* on page 41).

G9 Sound Browser

Sound Browser X

Sorted by

Instrument Category

Kick Drums	Snare Drums	Toms	Ride Cymbals	Crash Cymbals
Hi-Hats	Cymbals SFX	Percussion 1	Percussion 2	Sounds SFX

Number	Instrument	Cat
001	14" Collectors Maple C	AC
002	14" Collectors Maple S	AC
003	14" Collectors Maple CS	AC
004	14" Collectors Maple Rim	AC
005	14" Collectors Maple X-Stick	AC
006	14" US Vintage C	AC
007	14" US Vintage S	AC
008	14" US Vintage CS	AC
009	14" US Vintage Rim	AC
010	14" US Vintage X-Stick	AC
011	Broadkaster VBE CS	AC

9.3.3.4 ASSIGNMENT OF SECOND SOUNDS

To assign a second sound to the currently active pad component (e.g. Head or Rim), proceed as follows:

1. Turn **[on] Second Sound Select**.
2. Choose a sample from the **Second Sound Browser** by tapping the name field.
3. Adjust the second sound layer volume in relation to the primary component sound by tapping the **[Volume Second Sound]** dial and move the slider as desired.
4. Evaluate your adjustments by tapping the **[Preview]** button or playing the according pad component.
5. (Optional) Tune all second sound samples using the **Tuning Coarse** and **Tuning Fine** features.
6. Select the feature state when loading the kit (ON or OFF).
7. (Optional) Select another Pad component under Instrument select in module 2 and repeat steps 1-5.
8. Save the drum kit or create a new kit to memorize your edits.

 **Tip:** Assignment of second sounds will affect the active pad component only. Make sure you have the correct pad selected (module 1) and the desired component icon is highlighted in **Module 2** ➔ **Instrument Select**. It is recommended to keep **Auto Select** turned off (module 1) to avoid changing the pad accidentally.

9.3.4 HI-HAT VOLUME CONTROL

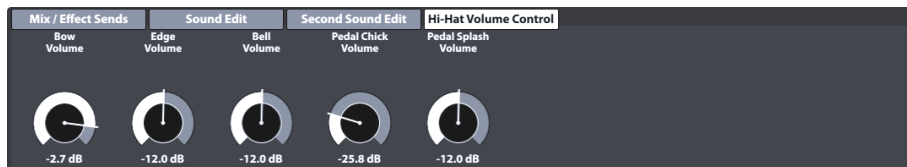

This function set allows for adjusting the volume of different Hi-Hat components relative to each other. The accessible parameters are:

Hi-Hat Volume Control - Parameters	
Hi-Hat Cymbal	Hi-Hat Controller
Bow Volume	Pedal Chick Volume
Edge Volume	Pedal Splash Volume
Bell Volume	

Use the sliders to adjust all component sounds relative to each other and use the **Mixer** function of the **Performance Mode** to adjust the global Hi-Hat volume in relation to the other Input channels (Pads).

i Important: Don't change the drum kit before saving. Edits in Hi-Hat Volume Control values as well as Mixer values are stored with the drum kit. Changing the drum kit without saving it will discard all modified values and restore previous values when loading the kit again.

9.4 MODULE 4

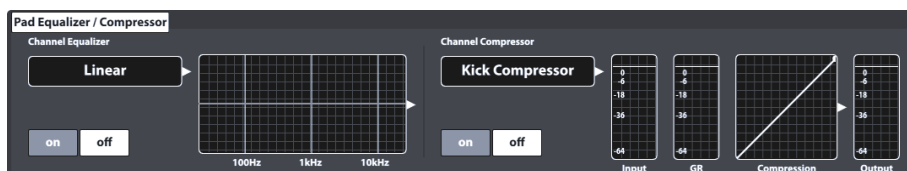

This function set hosts Equalizer and Compressor features which can be assigned to each Input channel displayed in **Module 1** of the **Kit Editor** Mode. Settings made in this module will be bundled with RAW MIDI signals and will consequently be audible in the direct outs when activated. (See also 12.1.4 Routing Drums & Routing Others on page 107)

9.4.1 PAD EQUALIZER / COMPRESSOR

The G9 offers a 3-band full parametric equalizer function as well as a compressor for every input channel/pad. Both features are implemented as insert type features. This way it is possible to shape the sound of each connected pad individually. Pad EQ and compressors are part of the drum kit parameters and are part of the mix audible in direct outputs and digital outs as well.

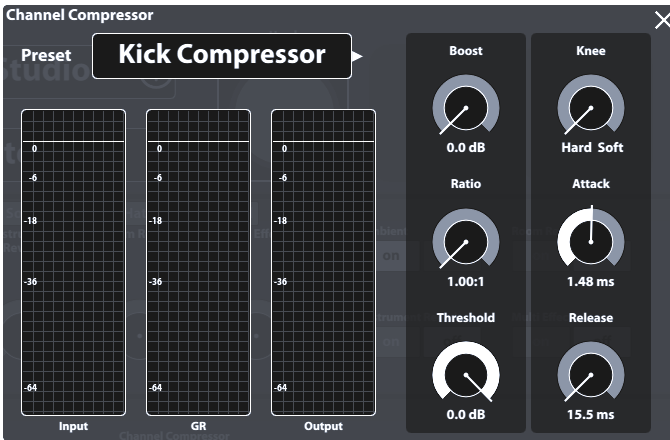
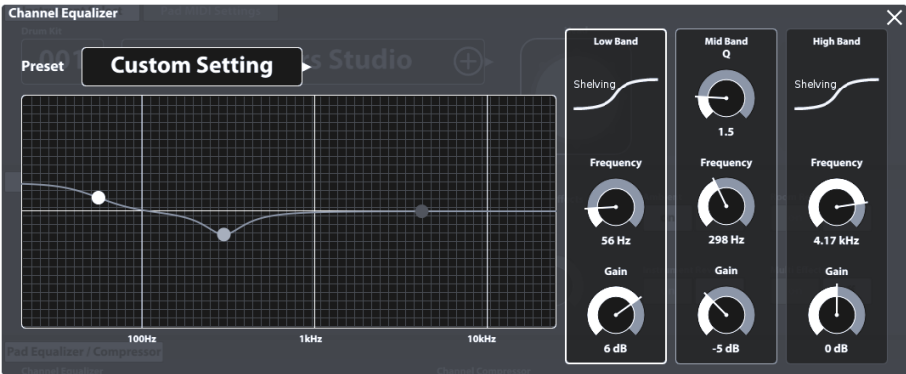

A selection of factory presets is provided to enhance your sound without deep knowledge in sound engineering. Load a preset and see how it affects the sound and the curve shapes of equalizer and compressor in module 4. The following presets are available:

G9 Presets – Pad EQ and Compressor	
Equalizer	Compressor
🔒 Linear	🔒 Kick Compressor
🔒 High boost 3dB	🔒 Snare Compressor
🔒 Bass boost 3dB	🔒 Bad Kick
🔒 Studio Snare A	🔒 Fat Snare
🔒 Studio Snare B	🔒 Drum Grouping
🔒 Drum Attack	🔒 Master A
🔒 Studio Kick A	🔒 Master B
🔒 Studio Kick B	🔒 Limiter A
🔒 Open Mix	🔒 Limiter B
🔒 Sweet Cymbals	🔒 Tube Saturation

Since the functioning of pad equalizers and pad compressors is identical with those available for the main stereo outputs (Master, Monitor and Headphones), we will focus on these features in **General Settings** mode. *(Please refer to section 12.2.1.1 Equalizer on page 113 and 12.2.1.2 Compressor on page 115)*

10 EFFECTS



The G9 is equipped with 4 different effect modules. **Ambience** hosts environmental sampling from **Funkhaus Studios Berlin**. **Instrument Reverb** and **Room Reverb** are two modules addressing traditional, generic types of reverb. Under the **Multi Effects** part of this mode you can control any effect that is not room simulation or reverb. Examples are echo effects or frequency modulation.

This section starts out by explaining the fundamental concept of effect parameter values as well as types of parameters between which the G9 distinguishes, followed by different ways of saving parameter values. Finally, each effect module is discussed individually focusing on module specific parameter properties.

The screenshot displays the G9 Effects interface with four effect modules:

- FX 1 Ambience Samples:** Includes a Metronome (90 bpm), Ambient (on/off), Pre Delay (0 ms), and FX 1 Send Level (0.0 dB).
- FX 2 Instrument Reverb:** Includes Monitor Out, Mix-Input, and Volume (-12 dB). Parameters include Instrument Reverb (on/off), Reverb Type (Hall Small), Pre Delay (18 ms), Reverb Time (8), Pre-High-Pass (118 Hz), High Shelf (-0.13 dB), High Damp (0%), Gate Time (off), and FX 2 Send Level (-30.7 dB).
- FX 3 Room Reverb:** Includes Headphone and Volume (-12 dB). Parameters include Room Reverb (on/off), Reverb Type (Hall Med), Pre Delay (28 ms), Reverb Time (68), Pre-High-Pass (157 Hz), High Shelf (6.00 dB), High Damp (13%), and FX 3 Send Level (-12.0 dB).
- FX 4 Multi Effects:** Includes Master, Mute, and Volume (-12 dB). Parameters include Multi Effects (on/off), FX Type (Mono/Stereo), Delay Time (75 ms), Feedback (24), Pre-Low-Pass (2.33 kHz), High Damp (100%), Send to Room Reverb (→ dB), and FX 4 Send Level (-12.0 dB).





On the right side, there is a vertical toolbar with icons for Performance, Kit Editor, Effects, Trigger Settings, General Settings, Tools, and Preview.

10.1 EFFECT PARAMETERS

Effect parameters are the third group of parameters stored in drum kits. Hence the name drum kit parameters. Like the drum kit parameters of the **Kit Editor** mode, Effects allow for storing each parameter directly into the kit.

For effect parameters that are characteristic of the effect, the G9 also provides the **preset** option. This enables the user to copy effects from one kit to another. The indirect preset method of parameter storage creates an additional node in the parameter hierarchy, so that the drum kit stores the preset name, which references the different parameter values contained. The entire **Effects** mode contains only drum kit parameters.

The following table gives an overview of all drum kit parameters available in Effects, and for which of these parameters the **preset** option is available:

Drum Kit Parameters -Effects			
Mode	Parameter Values	Direct (Custom)	Preset (Indirect)
 Effects			
	On/Off Switch expression	•	
	FX Send Level Faders	•	
	Level	•	
	Pre-Delay (Ambience)	•	
	Gate Threshold (Instrument Reverb)	•	
	Send to Room Reverb (Multi FX)	•	
	Every other FX 2-4 parameter ...	•	•
 Hint	Any change in value of one or more of the parameters shown above will cause the drum kit name to update. A preceding asterisk (*) will be added to the drum kit name in all Drum Kit fields in the user interface. The asterisk is a reminder to save the drum kit before changing it, so that altered kit parameters are retained.		
	Instances of the Drum Kit field are in: Performance → Module 1 → Drum Kit Kit Editor → Module 2 → Drum Kit		
Example	Drum Kit  *Drum Kit Name 		

10.2 EFFECTS MODULES – MUTUAL PARAMETERS









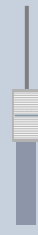

Every module of this mode can be switched **on** and **off** by the corresponding button on the left-hand side of the module. These buttons also have an instance in the **Kit Editor**, to preview effects without switching the mode. Level dials control the volume of each module, whereas **FX Sends** mixers allow for adjusting effect volumes of each pad individually. In other words: FX Sends control the effect "volumes" of the pads in relation to each other.

FX Sends 1-3

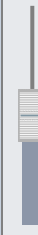
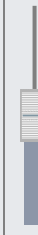
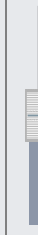
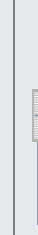
FX Send Levels ✕

Tom Grouping

Cymbal Grouping

														
-12 dB Kick	-12 dB Snare	-12 dB Tom 1	-12 dB Tom 2	-12 dB Tom 3	-12 dB Tom 4	-12 dB Ride	-12 dB Hi-Hat	-12 dB Crash1	-12 dB Crash2	-12 dB Aux 1	-12 dB Aux 2	-12 dB Aux 3	-12 dB Aux 4	-12 dB Aux 4

FX Sends Multi Effects with switchable Dry Signal:

FX Sends 4

Multi Effects Send Levels / FX 4

Tom Grouping Cymbal Grouping

-12 dB Kick	-12 dB Snare	-12 dB Tom 1	-12 dB Tom 2	-12 dB Tom 3	-12 dB Tom 4	-12 dB Ride	-12 dB Hi-Hat	-12 dB Crash1	-12 dB Crash2	-12 dB Aux 1	-12 dB Aux 2	-12 dB Aux 3	-12 dB Aux 4

Dry Signal

--	--	--	--	--	--	--	--	--	--	--	--	--	--

i *Hint: The default factory setting for FX Send sliders is -12 dB (centered). These values are overwritten as soon as you save the kit with deviant slider positions for the first time. Grouping of cymbals and toms is active by default and User/Device specific. The G9 remembers the last state for the next start. Grouping values are NOT stored with the drum kit!*

10.3 EFFECT PRESET PARAMETERS

An effect module offers preset parameters, when there is a preset field on the left-hand side (modules 2-4). Such parameters are located inside the dividing, vertical bars and contain all functionalities which form the fundamental characteristic of the effect. The G9 offers two distinct ways of saving effect parameter values:

- Saving out a preset without overwriting the effect properties of the active kit.
- Directly into the drum kit (Save the drum kit in e.g. **Performance**)

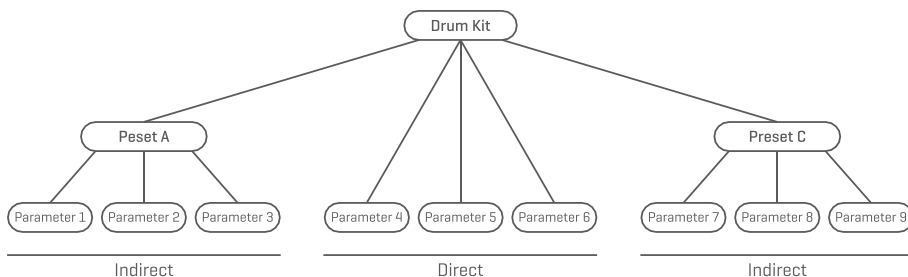

Chose a) if you want to make the effect parameter values of a module available for other drum kits as well or save the current parameters as a bookmark to explore other, alternative settings. Simply load the preset into a kit of choice and save the kit afterwards (alternatively create a brand-new kit). In case you neither save the kit, nor create a new one, changing the kit will restore the old effect parameter values once you reload the drum kit in **Performance Mode** or **Kit Editor**. However,

with a saved preset you have the chance to repeat the steps of loading the preset and saving the kit.

Choose b) if you just want to save the kit as it is including all effect parameter values. In this case it is recommended saving a new drum kit to avoid overwriting other presets. When choosing this option, you can still save out the effect parameters as a preset later.

i *Hint:* Effect parameter values, which are stored directly into the kit and don't derive values from a preset, are marked with "**Custom Setting**" in the preset field of the effect module. This way you always know if you must save a preset before assigning the effect values to a different drum kit.







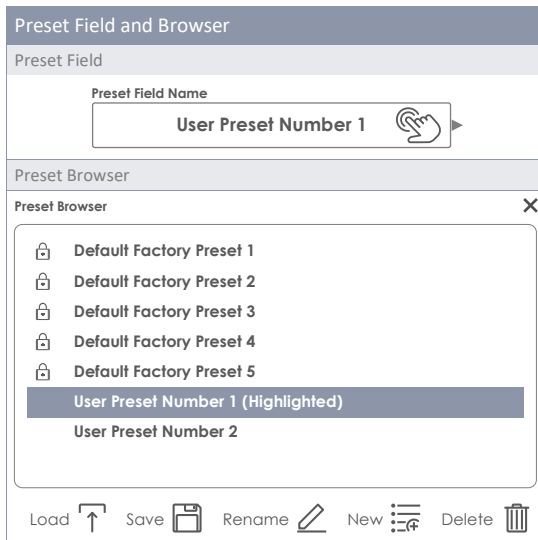

i *Important:* Don't change the kit before saving either the kit or its effect presets. Otherwise edits in effect values will be discarded!

10.4 EFFECTS PRESETS

The G9 provides a variety of options to manage preset libraries. You can access the library and its functions by tapping on a **[Preset]** Field next to a group of preset parameters. The G9 distinguishes between **Factory Presets** (preceding lock icon) and **User Presets** (without lock icon).



Regarding user presets, the palette of options is extended, since factory presets are not editable. Tap on a user preset and a factory preset in the preset select dialog for comparison. See the following table for reference:

Preset Management -Feature Shelf					
Preset Type	Function				
	Load	Save	Rename	New	Delete
 Factory Preset					
User Preset					

10.4.1 LOADING PRESETS

Proceed as follows:

1. Tap on the **[Preset]** field.
2. Tap once on the preset you want to load.
3. Tap **[Load]** in the Feature Shelf.

The dialog closes automatically, and the new preset is active. Save the drum kit to permanently connect the preset with the kit.

10.4.2 SAVING NEW PRESETS

In preparation please check whether the **[Preset]** field contains the name "**Custom Setting**". This indicates that values have changed and differ from those stored with the active drum kit.

With **Custom Setting** visible proceed as follows:

1. Tap on the **[Preset]** field.
2. Tap **[New]** in the Feature Shelf.
3. Name your preset using the keyboard
4. Confirm by tapping **[OK]**
5. (Optional) Save the active kit to replace the preset currently stored.

 **Hint:** A newly created effects preset will be added to the preset library only. It is not automatically stored with the active drum kit. To ensure that the new preset loads with the kit, you will have to additionally store the drum kit afterwards. If not, changing the kit will load all presets from the last saving.

10.4.3 DIRECT STORAGE OF PARAMETER VALUES

The G9 allows for storing parameter values directly into the Drum Kit without saving a preset. Instead of a preset name, the preset fields will display "**Custom Setting**". This is the case, when parameter values differ from an existing preset. It is still possible to save custom settings as a preset later and make certain parameter values available for other drum kits.

Note that preset types such as Routing Presets, Output EQ and Compressors are excluded from direct storage, since they are associated with the recording environment and not with the drum kit itself.

Two options of direct storage are available:

- a. Overwrite an existing drum kit
- b. Create a new kit

If you choose direct storage of parameter values proceed as follows:

1. Go to either

Performance → **Module 1** → **Drum Kit**

or

Kit Editor → **Module 2** → **Instrument Select** → **Drum Kit**

2. An asterisk (*) before the kit name indicates changes in directly storable values.
3. Tap the **[Drum Kit]** name field to open the **Drum Kit Browser**.
4. Choose one of the following options:
 - a. Overwrite an existing kit by selecting its name in the list and tapping **[Save]**.
 - b. Create a new kit by tapping **[New]** in the Feature Shelf, enter a name and confirm by tapping **[OK]**.

10.4.4 PRESET OVERWRITE

You can overwrite user presets with current values set in the interface. This function is not available for factory presets (preceding lock icon).

1. Tap the **[Preset]** field.
2. Tap on the preset name to be overwritten.
3. Tap **[Save]** in the Feature Shelf.

10.4.5 RENAMING PRESETS

Renaming a preset will affect the preset name only and retain individual parameter values. This option is only available for user presets (without preceding lock icon).

1. Tap the **[Preset]** field.
2. Tap once on a preset name in the drop-down list.
3. Tap **[Rename]** in the Feature Shelf.
4. Enter a new name for the preset using the keyboard.
5. Confirm by tapping **[OK]**.

10.4.6 DELETING USER PRESETS

Proceed as follows:

1. Tap the **[Preset]** field.
2. Tap once on a preset name in the drop-down list.
3. Tap **[Delete]** in the Feature Shelf.

10.5 MODULE 1

10.5.1 FX1 AMBIENCE SAMPLES



The Ambience module hosts room samples taken in Funkhaus Studios. Since a room responds to moving air in a characteristic and consistent manner, the possibilities of parameters are limited by the nature of the effect.

Ambience controls the time until the sound bounces off an obstacle resulting in an echo. The effect is designed to affect the sound of the kit globally, which follows the assumption that the whole kit is set up in the same room or environment. However, it is possible to adjust the volume of the effect for each pad using the **FX 1 Send Mixer**, which lets one turn off the effect by dragging the slider down completely for the pad of choice.

To adjust the **Ambience** (Echo) Effect of the kit, proceed as follows:

1. Turn **on** Ambient.
2. Set the **Pre-Delay** by dragging up the slider (range: 0-127 ms).
3. Use the **Level** dial to adjust the maximum volume of the Effect.
4. Tap on **FX 1 Send**, if you want to change the effect volume a pad individually (optional).
5. Save the effect with the drum kit once you are happy.

10.6 MODULE 2

10.6.1 FX 2 INSTRUMENT REVERB



This module hosts classic and generic algorithms to simulate Instrument specific reverb. Some **Reverb Types** are traditionally generated electronically, whereas others (e.g. Plate) emulate mechanical devices designed to add artificial reverb to the dry recording.

The difference between Instrument Reverb and **Room Reverb** is more conceptual than a property. Does an instrument possess reverb if there was no room? This question is certainly a philosophic one. Both modules offer the same parameters except for **Gate Threshold** (Instrument Reverb only). With Room Reverb you can place the whole kit in an environment and with the addition of **Instrument Reverb**, it is possible to add reverb effects on top of the environment - selectively for each input channel. In that sense the additional parameter **Gate Threshold** is of an artificial nature and thus

belongs to Instrument Reverb exclusively. Factory presets provided for Instrument Reverb focus on instrument specific effects but derive their characteristics from the same parameters and value ranges.

10.6.1.1 REVERB TYPES AND PARAMETERS

The following reverb types and parameters are available:

Reverb Types (Instrument and Room)	
Plate1 Small	Plates produce a mechanically generated reverb without early reflections. This is a simulation of a smaller size plate with a certain characteristic.
Plate1 Med	Plates produce a mechanically generated reverb without early reflections. This is a simulation of a medium size plate with a certain characteristic.
Plate1 Large	Plates produce a mechanically generated reverb without early reflections. This is a simulation of a large plate with a certain characteristic.
Plate2 Small	Plates produce a mechanically generated reverb without early reflections. This is a simulation of a smaller size plate with a different characteristic than Plate 1 Small.
Plate2 Med	Plates produce a mechanically generated reverb without early reflections. This is a simulation of a medium size plate with a different characteristic than Plate 1 Med.
Plate2 Large	Plates produce a mechanically generated reverb without early reflections. This is a simulation of a large plate with a different characteristic than Plate 1 Large.
Room Small	This is an algorithm simulating a small room where early reflections are accepted.
Room Med	This is an algorithm simulating a medium size room where early reflections are accepted.
Room Large	This is an algorithm simulating a large size room where early reflections are accepted.
Hall Small	Algorithm simulating a smaller concert hall with early reflections and a longer decay than room simulations
Hall Med	Algorithm simulating a medium size concert hall with early reflections and a longer decay than room simulations
Hall Large	Algorithm simulating a large concert hall with early reflections and a longer decay than room simulations

Each **Reverb Type** can be customized by the following parameters:

Reverb Types - Parameters				
Parameters	Description	Value Range	Storage	
			Direct (Custom)	Indirect (Preset)
On/Off	Activate/deactivate the reverb module globally	on/off	•	
Pre-Delay	The amount of time before the onset of reverb. Longer delays leave the dry sound untouched in its attack and preserve clarity of the sound. Short delays blend with dry signals earlier at the cost of crispness, if reverb starts before the fully developed attack of the dry sound.	0 - 250ms	•	•
Reverb Time	Controls the length of the reverb after Pre-Delay . Reverb time is also known as "Decay Time".	0 - 127	•	•
Pre-High-Pass	Hi-Pass pre-cuts the low dry-frequencies for the reverb algorithm (= Low Cut) and lets the high frequencies cut through. Set the frequency threshold below which low frequencies are cut off. The fall-off curve avoiding sharp cuts is fixed and not editable.	0 - 1000Hz	•	•
High Shelf	Increases or reduces frequencies above the shelf frequency at 1.5kHz (Center frequency, turning point). Set positive values for increase and negative values for a decrease.	(-12) – (+6) dB (@1.5kHz)	•	•
High Damp	Filter that causes the high reverb frequencies to decay faster than the rest. The slider ranges from 0% (no damping) up to 100% (max damping)	0 - 100 %	•	•
Gate Threshold	Cuts off the reverb completely after dropping below the set Gate Threshold Level. A value of 0 switches the effect off, "On-values" range from (-114 dB) up to (-24 dB).	(-24) – (-114) dB	•	
Level	Level of attenuation of reverb. Controls the volume of the reverb compared to the dry sound.	-∞ - 0 dB	•	

10.7 MODULE 3

10.7.1 FX3 ROOM REVERB

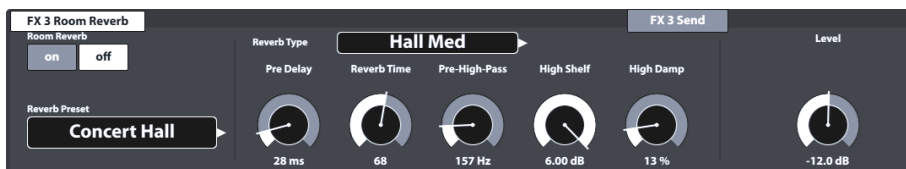

The features available in this module represent the generic counterpart of the **Ambience** module. It provides the same **Reverb Types** and parameters as **Instrument Reverb**, but with focus on the room specific qualities of reverb. Use this effect section to add reverb to a dry sound when ambience samples are not available, or simply to create sounds of traditional recordings with electronically generated reverb. Presets provided for this module reflect different environmental characteristics.

Since the functioning of this effect section is identical with the module **Instrument Reverb**, please refer to the previous section for delineation of concepts, explanation of reverb types and parameters.

10.8 MODULE 4

10.8.1 FX 4 MULTI EFFECTS

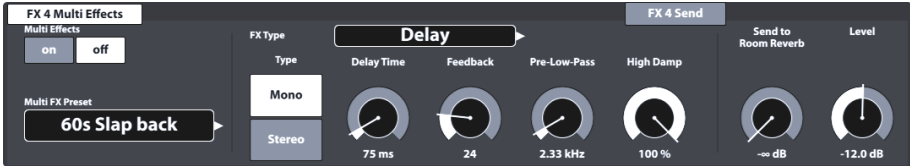

Effects in this module comprise everything that is not associated with **Ambience**, **Instrument Reverb** or **Room Reverb** as for example frequency modulation. Results are obtained by using algorithms to create a certain effect.

The following tables give you an overview of available algorithms and their parameters. Unlike the reverb modules the parameters of the **Multi Effects** module change depending on the algorithm selected. Mutual effect parameters are drum kit parameters and are stored directly in the kit.

Multi Effects – Mutual Parameters		
Parameter	Value Range	Description
Level	-∞ - 0 dB	Controls the Level of balance between Dry and Wet signal sent to the Mixer . If "Dry" is turned on in FX 4 Send (see page 62) (corresponds to "Side chain" configuration), Level will control the Balance between dry and wet signal sent to the Mixer . With "Dry" turned off, the effect is configured as an Insert type effect, where Send level and Level have identical functionality and contribute to the presence of the effect in the Mixer in the same fashion. Choose low fader positions for a quiet effect and high positions for more present effects.
Send to Room Reverb	-∞ - 0 dB	With Room reverb active for the Dry sound you might also feel the need of room simulation in multi effects as well to make both live in the same environment. Low fader positions will send a highly attenuated signal and will consequently add less room component to the effect. High slider positions will emphasize the environment in the effect mix
 Hint	These parameters are not part of the preset management but are stored as drum kit parameters using the direct method (Save the drum kit).	

The following parameters are associated with a **Drum Kit** and describe the fundamental characteristics of an effect. Therefore, both options of storage are available: direct method ("Custom Setting") and indirect method (presets). Edits in parameter values can be memorized by either saving the Drum Kit or creating/overwriting an effect preset.

Wah-Wah				
The Wah-Wah effect is created by dynamically “brushing” through the frequency spectrum of the dry signal utilizing a specific audio filter. Instead of the classic pedal control, the G9 uses the Velocity of the stroke to control the movement of the filter along the frequency spectrum.				
Parameters	Range	Unit	Dry/Wet	Description
Filter Type	Low Pass, Band Pass			Choose between a High Cut (Low Pass) or a Band Pass Bell filter. Underlying constants: Transition steepness: 12 dB (Low Pass)
Frequency	100Hz - 8kHz	Hz		Depending on the chosen Filter Type , this parameter sets the center frequencies of Low Pass or Band Pass for the stroke velocity value of 0 (starting point).
Resonance	1-127			Corresponds to the “Q” factor in Equalization. This parameter controls the width of the bell filter shape (Band Pass) and in case of choosing the Low pass option, Resonance will control the bell shape of the “overshooting” at the filter Frequency . Set the width of the bell filter shape from 0 (no resonance, wide) in the lowest slider position up to 127 (max resonance, narrow) in the highest slider position.
Sensitivity	0-100	%		Sensitivity defines to what extend the dynamics of a stroke on a pad (velocity) is allowed to drive the movement of the specified filter along the possible frequency spectrum. The filter is defined by the parameters Filter Type , Start Frequency and Resonance . Technically, Sensitivity works as a multiplier (attenuator) for the effect intensity at a specific stroke velocity level. Example: With Sensitivity set to 50%, a stroke on a pad with maximum velocity of 127 will cause the filter to move only halfway along the possible frequency range in the specified Direction , whereas the same stroke velocity with Sensitivity of 100% would exhaust the full frequency spectrum possible. Values range from 0 (off) up to 127 (100%).
Direction	Up, Down			Set the direction of movement for the Filter Type starting at Frequency .
Decay	(-10) ms – (+5) s	s		Decay determines how fast the envelope follower , which controls the filter activity or attenuation, returns to its starting position after having tracked the maximally allowed movement defined by stroke Velocity and Sensitivity . Aside from the filter movement, you can additionally control the presence of the filter effect in the mix by adjusting the decay rate of the envelope follower. Values range from -10 ms (fast) up to 5 seconds (slow) with a nonlinear progression of decay time while moving the slider.

Distortion / Saturation				
<p>Overloads the audio signal with gain and adds additional harmonic frequencies to the mix, resulting in a fuller but in case of distortion also edgier sound. This method is prone to scaling up frequency amplitudes along the frequency spectrum, with the result, that the amplitude would surpass 0 dB at more and more frequencies. Consequently, audio Clipping is forced to generate the effect of added harmonics in the audio mix.</p> <p>Two methods are provided, who differ in the way of dealing with clipping: Distortion and Overdrive. While Distortion radically levels amplitudes crossing 0 dB (hard clipping), Overdrive rounds off the amplitude at the boundaries of bandwidth, where clipping would occur (soft clipping). Which method provides the better results depends on the audio material (samples) utilized.</p>				
Parameters	Range	Unit	Dry/Wet	Description
Type	OD, DS			Choose between two methods of effect generation with distinct characteristics: OD (Overdrive) and DS (Distortion) . While Overdrive models the characteristics known from tube amplifiers, Distortion provides the characteristics of distortion typical of Transistor amplifiers.
Drive	0-100	%		This parameter controls the intensity of the effect (scaling up frequency amplitudes). Values range from 0% (linear) up to 100% (max Drive amount).
Frequency	250Hz - 8kHz	Hz		This parameter determines the frequency spectrum affected by the chosen effect Type . If you prefer to saturate only the lower end of the frequency spectrum, set the desired filter frequency for the underlying Low Pass filter with transition steepness of 12 dB.
Post Gain	(-∞) - 0	dB		Adding this effect type will considerably amplify the output signal. With post gain you can attenuate the mix. Values range from -∞ (muted) up to 0 (min attenuation).

Chorus				
<p>Creates a fuller sound by the illusion of multiple instruments being played simultaneously. The effect is achieved by doubling the dry sound and offsetting the detuned duplicate slightly in time (fixed delay time of 20 ms). The frequency modulation of the duplicate signal is controlled by different LFO waveforms available.</p>				
Parameters	Range	Unit	Dry/Wet	Description
Type	Sine, Triangle			Determines the displacement waveform of the underlying Low Frequency Oscillator (LFO). This is a control curve outside the audible spectrum of human hearing (below 20 Hz, see also Modulation Rate). With the waveform you can give the effect distinct characteristics. Sine produces smooth characteristics, while triangle allows for more earthy characteristics of the delayed duplicate.
Modulation Rate	0-10	Hz		Controls the speed of LFO displacement and thus the speed of the wavering sound. This parameter controls the period of the LFO waveform.
Modulation Depth	0-127			Controls the intensity of the effect by adjusting the height of the LFO amplitude. The parameter values range from 0 (off) to 127 (intense).

Flanger				
<p>Doubles the dry signal and displaces it within a short delay time, so that dry signal and duplicate are not perceived as 2 distinct sounds. Compared to similar effects, Flangers delay the duplicate signal slightly more than traditional Phaser effects and Flangers accept feedback signals to process the modulation, resulting in an effect similar to the sound of a jet plane. Flangers use cone filtering for the frequency modulation of the duplicate signal. The dynamics of filter movement from high frequencies to low frequencies is controlled by an LFO (sine).</p>				
Parameters	Range	Unit	Dry/Wet	Description
Modulation Rate	0-10	Hz		Controls the length of the LFO waveform period and thus the frequency of the generated sweep.
Modulation Depth	0-127			Controls the intensity of the effect by adjusting the height of the LFO amplitude. The parameter values range from 0 (off) to 127 (intense). This parameter controls how noticeable or settled the effect is. Starting at high frequencies you specify how far the underlying LFO driven Comp Filter is allowed to travel into the low frequency spectrum while it is sweeping back and forth.
Delay Time	0.125 -10	ms		Specify the delay time for the offset and modulated duplicate signal.
Feedback	0-127			Controls the number of signal copies feeding back into the effect unit to enhance the comp filter effect, until the effect fades out. Choose low fader positions for less feedback signals and high fader positions for lots of feedback signals and strong enhancement of the filtering.

Phaser				
<p>The G9 models the effect using a 6-notch filter directly applied to the dry signal. Like Wah-Wah, the effect is generated by "brushing" with the filter through the frequency spectrum. However, while the dynamics of movement of Wah-Wah are controlled by the intensity of the stroke, the movement using Phaser is controlled by a sine LFO waveform. In comparison to Flangers, Phasers allow for filter movement around the notch frequencies, whereas filters creating the Flanger effect start at high frequencies and travel down to lower frequency spectrums. The parameters provided for Phasers model the movement of the filter as well as the shape of the filter (Resonance).</p>				
Parameters	Range	Unit	Dry/Wet	Description
Modulation Rate	0-10	Hz		Controls the length of the LFO waveform period and thus the frequency of the generated sweep.
Modulation Depth	0-127			Controls the intensity of the effect by adjusting the height of the LFO amplitude. The parameter values range from 0 (off) to 127 (intense).
Resonance	0-127			Emphasizes certain frequencies in a period or sweep. Corresponds to the Q factor in Equalization. Set the width of the bell filter shape from 0 (no resonance) in the lowest slider position up to 127 (max resonance, wide) in the highest slider position. With this parameter you control the shape around all peaks of the filter at the same time.

Auto Pan				
Pans the sound between the left and the right speaker in 180° out of phase. The volume of both channels (Left and right) is driven by a sine LFO waveform.				
Parameters	Range	Unit	Dry/Wet	Description
Modulation Rate	0-20	Hz		Controls the length of the LFO waveform period and thus the frequency of the alternating effect.
Modulation Depth	0-127			Controls the intensity of the panning effect. Values range from 0 (equals Mono) to 127 (full alternation between 63L and 63R values).

Bit Crusher				
This effect adds edginess to your sound by reducing the waveform resolution of the signal. (along the amplitude and the period).				
Parameters	Range	Unit	Dry/Wet	Description
Bit Resolution	0-16	bit		This parameter pixelates the audio signal and reduces the resolution of the signal (vertical direction, Bit Depth). Values: 0 (no reduction), 1 bit up to 16 bits
Down Sampling	1-16			Reduces the resolution of the wave period by lowering the sampling rate. (horizontal direction, quality) Values are defined as a factor of reduction and range from 1 (no reduction) up to 16 (reduction down to 1/16 of the original sampling rate).
Brightness	0-100	%		Bit Resolution and Down sampling are prone to increasing the proportion of high frequencies in the output signal. Brightness adjusts the frequency of a Low Pass (High Cut) filter with a transition steepness of 12 dB. Low slider positions correspond to low filter frequencies and less high frequencies, whereas high slider positions translate to high filter frequencies and thus, filter less highs.

Delay				
Records a segment of the played sound and plays it back repeatedly (multi-echo).				
Parameters	Range	Unit	Dry/Wet	Description
FX Type	Mono, Stereo			Mono creates a mono signal audible on both speakers simultaneously. In stereo mode the delayed signals alter between the left and the right speaker. The Mono signal is moved to the left speaker and the second signal for the stereo effect is inserted in between the Mono signal on the opposite speaker. Consequently, this doubles the feedback frequency (or cuts the Delay Time into half).
Delay Time	1-1365	ms		Control the time in-between repeats.
Feedback	0-127			Controls the number of repeats until the effect fades out. Choose low fader positions for less repeats and high fader positions for lots of repeats.
Pre-Low-Pass	2-8	kHz		Cuts the high frequencies of the dry signal above the set cut frequency. Only frequencies below the threshold frequency are passed on to generate the effect. The slope steepness of the filter is 12 dB. Pre-Low-Pass only works on the delayed sound. The dry signal itself is not affected.
High Damp	0-100	%		Filter that causes the high reverb frequencies to decay faster than the rest. The slider ranges from 0% (no damping) up to 100% (max damping). Choose higher values to create a delay that runs away into distance, while low damping values let the delay stay in the vicinity of the dry sound.

11 TRIGGER SETTINGS



In the **Trigger Settings** mode, you can adjust the behavior of the sensors in the pads further customizing the e-drum. Note that the top three dials on the left-hand side change to affect the **High Level**, **Head/Bow Threshold** and the **Head/Bow Gain** faders.

It is recommended to use factory presets for pads (if available) by browsing the **Trigger Bank** and **Setup** menus. However, the G9 provides a range of features to calibrate any analogue trigger pad to your playing style. Learn how to create custom trigger banks and setups and gain an understanding of the underlying parameters.

11.1 MODULE 1

11.1.1 TRIGGER DETECTION

The function set Trigger Detection hosts two main feature categories:

- Selection of input Channels (Pads)
- Monitoring of Trigger Performance (Peak Monitoring)

Not only the appearance of this module is the same as the **Channel Select** function set in **Kit Editor** → **Module 1**, but also its functioning is identical. However, keep in mind that trigger monitors only update in the active mode and won't necessarily display the same color values in the peak row when switching back and forth between Kit editor and Trigger settings.

Before moving on, it is crucial to understand that all functions available in modules 2 and 3 strongly relate to the pad selected under **Input Channels**. Whenever adjustment in these modules seem to have no impact on the trigger performance, you might check if the pad you are playing on matches the selected input channel. The same goes for the selected pad component in module 2.

11.1.1.1 INPUT CHANNELS

The main purpose of the channel select feature is to select connected pads for reasons of assigning different sounds (Kit Editor) or editing their trigger parameters (Trigger Settings). The Pad order from left to right matches the order of **Trigger Inputs** of the rear panel.

Select a connected pad by tapping the button above the pad name. A selected pad is highlighted by a surrounding frame.

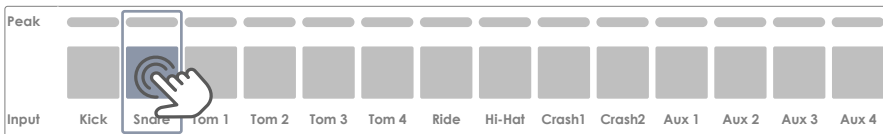



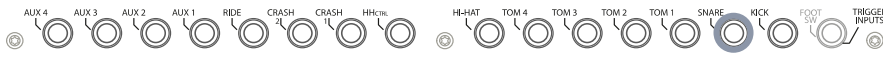

G9 Ports – Input Channels

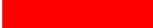

The **Peak** row remembers the highest velocity value detected while playing and for each pad separately. It works in the same way as the peak rows available in other modules and returns the **maximum velocity across all pad components**. Consequently, you are informed about a pad issue when spotting the peak color. The deeper analysis, however, must follow in **Trigger Settings** mode using the **Pad Monitor** (module 4).

In the **Peak** row the velocity scale of 0-127 is translated into color values which depend on the selected UI Theme. Check your UI Theme first to be able to interpret the colors returned under Peak. (see **General Settings** → **Module 4** → **Device** → **UI Theme**)

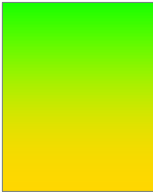
The following table shows the relation between velocity value, UI theme and color gradients used:

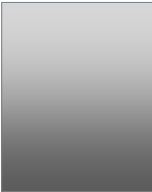
Color Scales for Peak Detection by UI Theme			
	UI Theme		
MIDI Velocity Value	GEWA Red GEWA Classic GEWA White Tritanopia	Protanopia Deuteranopia	Grayscale
Peak (126-127)			
Normal High (125)			
Normal Low (1)			

11.1.1.2 AUTO SELECT

With Auto Select it is possible to select an input channel by playing the connected pad on one of its components. Turning this feature **[on]** will add the play-to-select feature to the standard select-by-tapping function on the screen. It is recommended to use this feature sparingly, since it can cause confusion when touching other pads accidentally.

11.1.1.3 PEAK DETECTION

With this function you can reset the peak monitor of the active module to the color value assigned to the velocity level of 0. This is especially important to check if altered trigger parameters work as desired. Tapping **[Reset]** refreshes the Peak Monitor and deletes the detection history.

11.2 MODULE 2

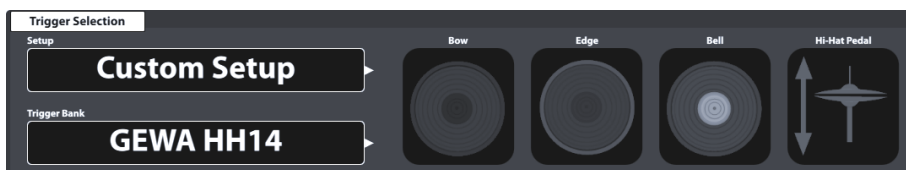

11.2.1 TRIGGER SELECTION

11.2.1.1 SETUP

A collection of trigger banks can be grouped under a setup, which contains all trigger banks assigned to the input channels available. As a result, you can load all trigger banks at the same time by just loading the setup. This is especially useful when experimenting with trigger bank parameters of various pads. This way you can save a setup and switch back and forth between different setups for comparison of the trigger behavior. As in **Effects Mode** it is not mandatory to save edits in parameter values (module 3) as a **Trigger Bank** (module 2). The **direct storage** feature is also available

when saving a setup. The trigger bank preset field will show “**Custom Setting**”, whose parameter values can still be converted into a preset later. Don’t forget to save or create a setup after the creation of a trigger bank, otherwise the setup will recall previous trigger banks when loading it next time. However, since the new trigger bank exists, you can always make up for this by assigning the correct trigger bank preset and saving the setup again.



With the Setup on top, the preset hierarchy of the trigger settings parameters is structured as follows:

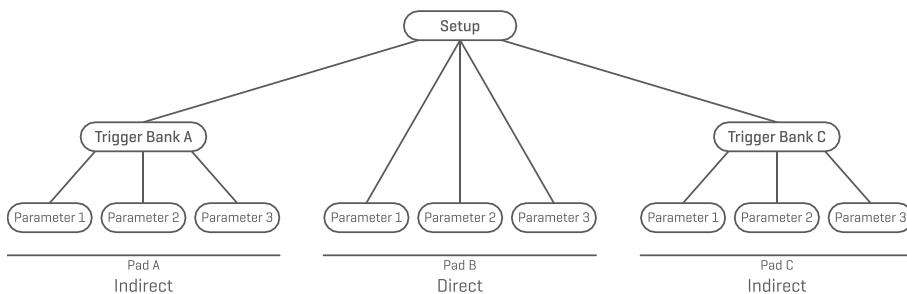

11.2.1.1.1 STANDARD SETUPS

These **Setups** assign default **Trigger Bank** presets to all **Input Channels** available which store parameter values optimized for GEWA pad components and can be found in the **Trigger Bank Selection** browser under **Default Presets**.

The **Standard Setups** are designed to match common GEWA configurations of pads available. Check your configuration and assign the matching Trigger bank for best trigger performance. See the following table how table how each standard setup configures the Input channels with Trigger Banks (Presets):

Factory Setups by GEWA Shell Configuration			
Input	Setup		
	GEWA STUDIO Trigger Bank	GEWA PRO 5 Trigger Bank	GEWA PRO 6 Trigger Bank
Kick	GEWA Kick 18inch	GEWA Kick 18inch	GEWA Kick 18inch
Snare	GEWA Snare 12inch	GEWA Snare 14inch	GEWA Snare 14inch
Tom 1	GEWA Pad 10inch	GEWA Tom 10inch	GEWA Tom 10inch
Tom 2	GEWA Pad 10inch	GEWA Tom 12inch	GEWA Tom 12inch
Tom 3	GEWA Pad 12inch	GEWA Tom 14inch	GEWA Tom 12inch
Tom 4	GEWA Pad 12inch	GEWA Tom 14inch	GEWA Tom 14inch
Ride	GEWA Ride 18inch	GEWA Ride 18inch	GEWA Ride 18inch
Hi-Hat	GEWA HH 14inch	GEWA HH 14inch	GEWA HH 14inch
Crash 1	GEWA Crash 14inch	GEWA Crash 14inch	GEWA Crash 14inch
Crash 2	GEWA Crash 14inch	GEWA Crash 14inch	GEWA Crash 14inch
Aux 1	GEWA Tom 10inch	GEWA Tom 10inch	GEWA Tom 10inch
Aux 2	GEWA Tom 10inch	GEWA Tom 10inch	GEWA Tom 10inch
Aux 3	GEWA Tom 10inch	GEWA Tom 10inch	GEWA Tom 10inch
Aux 4	GEWA Tom 10inch	GEWA Tom 10inch	GEWA Tom 10inch
 Hint	<i>The default Factory Setup is GEWA STUDIO. If you have purchased a different GEWA Shell configuration, please load the corresponding setup first to ensure the best trigger performance. (See also section 11.2.1.3.1 Loading Presets on page 84)</i>		

The setups shown above can also be used as a starting point for customized Hardware setups.

The following sections will guide you through the process of creating new setups. You will also learn how to edit, rename, modify and delete existing presets.

11.2.1.2 TRIGGER BANK

As opposed to the sounds assigned to pad components (Kit Editor), trigger parameter values are not stored directly into the drum kit, but in their own preset, which is independent from any kit. This makes sense, because trigger detection is hardware related and not dependent on any sound parameter. When changing a sound, all trigger parameter values remain the same, since you are still playing the same hardware. For this reason, the whole trigger section works differently from the kit editor, although its appearance is similar.

Trigger banks are stored per input channel (pad), containing all real-time parameter values of each pad component. The difference in conception of **Sound Select** (Kit Editor) and **Trigger Bank** (Trigger settings) figures in the fact that the name in the trigger bank field does not update when tapping on the different component icons of module 2. However, the parameters in **Trigger Settings** → **Module 3** will update depending on the active component.

Other than the **Sound Select** field in the kit editor, the trigger bank field is a **preset field**, which adds another step in the hierarchy of parameter value storage. It follows the rules and principles of the G9 preset management system.

11.2.1.3 PRESETS - SETUP AND TRIGGER BANK

The G9 provides a variety of options to manage preset libraries. You can access the library and its functions by tapping on a **Preset Field**. Regarding Trigger Settings, the relevant preset fields for setups and trigger banks are located in module 2. The parameter values stored in these preset fields are derived from module 3. See the following Screenshot for clarification:



The G9 distinguishes between **Factory Presets** (preceding lock icon) and **User Presets** (without lock icon). Both appear in the list that pops up when tapping a preset field. Regarding **Setups**, fields and browsers look as follows:

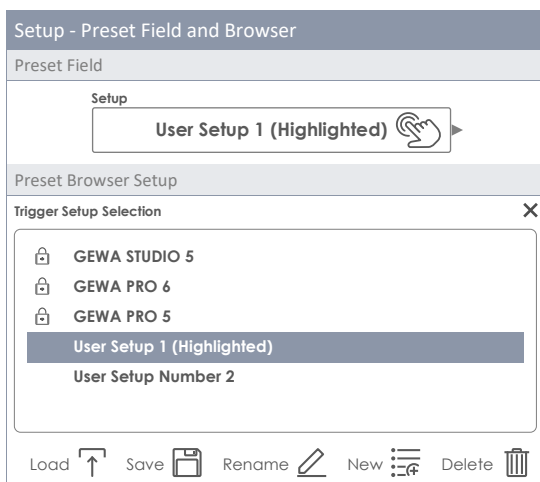

In case of **Trigger Banks**, the corresponding preset browser is structured as follows:

Trigger Bank - Preset Field and Browser

Preset Field



Trigger Bank

GEWA Snare 12inch 

Preset Browser – Trigger Bank Factory

Trigger Bank Selection

Default Presets	User Presets		
Kicks	Pads	Cymbals	Hi-Hats
GEWA Kick 18inch	GEWA Snare 12inch	GEWA Crash 14inch	GEWA HH14
GEWA Kick Pad	GEWA Snare 14inch	GEWA Ride 18inch	
	GEWA Tom 10inch		
	GEWA Tom 12inch		
	GEWA Tom 14inch		
	GEWA Pad 10inch		
	GEWA Pad 12ich		





Load  New 

Feature Shelf

Preset Browser – Trigger Bank User













Trigger Bank Selection ✕

Default Presets	User Presets		
Kicks	Pads	Cymbals	Hi-Hats
My Custom Kick Pad	My Custom Snare		Customized GEWA HH
	My Custom Tom 12in		

Load  Save  Rename  New  Delete 

Feature Shelf

At the bottom of each list, you will find all functions applicable for each group of presets, depending on the highlighted entry. Regarding user presets, the palette of options is extended, since factory presets are not editable. Tap on a user preset or factory preset in the preset select dialog for comparison. The following table for gives an overview of the functions available:

Preset Management -Feature Shelf					
Preset Type	Function				
	Load	Save	Rename	New	Delete
 Factory Preset				  	
User Preset				  	

The next sections discuss the functionalities of the feature shelf.

11.2.1.3.1 LOADING PRESETS

Proceed as follows:

1. Tap on the **[Preset]** field.
2. Tap once on the preset you want to load.
3. Tap **[Load]** in the Feature Shelf.

The dialog closes automatically, and the new preset is active.

11.2.1.3.2 SAVING NEW PRESETS

In preparation please check whether the **[Preset]** field contains the name “**Custom Setting**” or “**Custom Setup**”. This indicates that values have changed and differ from those stored with the active **Trigger Bank** or **Setup**.

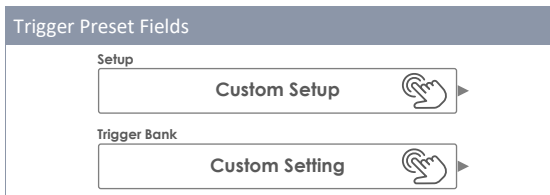

With **Custom Setup/Setting** visible proceed as follows:

1. Tap on the **[Preset]** field.
2. Tap **[New]** in the Feature Shelf
3. Name your preset using the keyboard.
4. Confirm by tapping **[OK]**.



Hint: A newly created trigger bank will be added to the preset library only. It is not automatically stored with the active setup. To ensure that the new preset loads with the setup, you will have to store the setup afterwards as well. If not, previous trigger banks will be remembered the next time you load the setup.

11.2.1.3.3 DIRECT STORAGE OF PARAMETER VALUES - SETUPS

The G9 allows for storing parameter values directly into the setup without saving individual presets for trigger banks. Instead of a preset name, the **Trigger bank field** will display “**Custom Setting**”. This is the case, when parameter values differ from an existing preset. It is still possible to save custom settings as a preset later and make certain parameter values available for other setups as well.

Two options of direct storage are available:

- a. Overwrite an existing setup
- b. Create a new setup

If you choose direct storage of parameter values proceed as follows:

1. Tap the **[Setup]** field to open the **Trigger Setup Selection** browser.

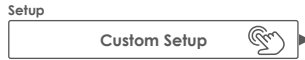

2. Choose one of the following options:
 - a. Overwrite an existing setup by highlighting a name in the list and tapping **[Save]**.
 - b. Create a new setup by tapping **[New]** in the Feature Shelf, enter a name and confirm by tapping **[OK]**.

11.2.1.3.4 OVERWRITE PRESETS

You can overwrite user presets with current values set in the interface. This function is not available for factory presets (preceding lock icon).

1. Tap the **[Preset]** field.
2. Tap on the preset name to be overwritten.
3. Tap **[Save]** in the Feature Shelf.

11.2.1.3.5 RENAMING PRESETS

Renaming a preset will affect the preset name only and retain individual parameter values. This option is only available for user presets (without preceding lock icon).

1. Tap the **[Preset]** field.
2. Tap once on a preset name in the drop-down list.
3. Tap **[Rename]** in the Feature Shelf.
4. Enter a new name for the preset using the keyboard.
5. Confirm by tapping **[OK]**.

11.2.1.3.6 DELETING USER PRESETS

This function is not available for factory presets (preceding lock icon). Proceed as follows:

1. Tap the **[Preset]** field.
2. Tap once on a preset name in the drop-down list.
3. Tap **[Delete]** in the Feature Shelf.

11.2.1.4 PAD COMPONENTS

The pad component icons are located on the right-hand side of module 2. You can tap on an icon to activate the component, giving access to its parameters in module 3. The appearance of the icons and their naming depends on the **Trigger Bank** assigned. Assigning a cymbal trigger bank will display Bow/Bell/Edge icons and cymbal parameters in module 3, even though the corresponding input channel is labeled as e.g. "Snare". This means in most cases you can convert a pad input channel to a cymbal input and vice versa. However, not all components of the trigger bank might be accessible due to a different hardware design of the channel on the trigger board.

When gaining an understanding of the G9 Trigger Settings, it is important to point out that all function sets and parameters of module 3 always refer to the selected pad under **Input Channels** and its active component (component icon in module 2). By changing either pad or component, parameter values in module 3 will update accordingly. To keep track of your trigger settings, try to look at this mode as a cascade of Input Channel, Component and Parameters:

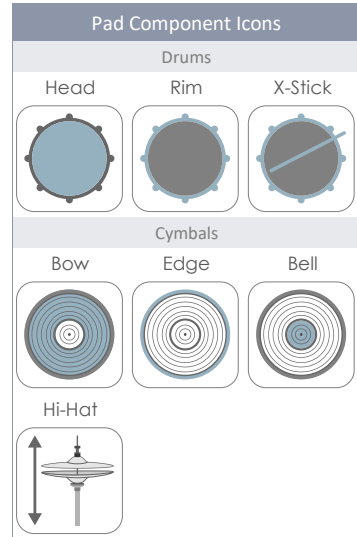
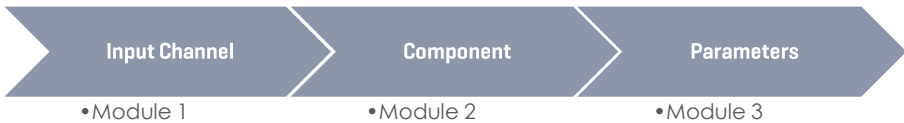

11.3 MODULE 3

This module hosts all relevant accessible parameters to fine tune the trigger performance of your pads. Here you can calibrate your G9 to 3rd party equipment and optimize the communication between pads and console.

In case of trigger issues, please start based of the **Setups** and **Trigger Banks** provided and sparingly experiment with the parameters available.

i **Tip:** If available, please load provided factory **Trigger Banks** first. Regarding GEWA equipment, the **Standard Setups** assign trigger banks for GEWA equipment to all input channels.

This section focusses on the explanation of parameters and terms, so that you gain an understanding which parameter to examine when a certain problem occurs.

Finally, when you are happy with the performance, save the parameter values as a preset (Trigger Bank or directly as a Setup). Preset Management regarding Trigger Settings is explained in detail in the previous section (see 11.2.1.3 Presets - Setup and Trigger Bank on page 82).

The accessible trigger parameters depend on the component to be adjusted. Therefore, we can compile all parameters in a simple map. In the UI, Parameters are spread over 2 function sets in module 3: **Trigger Settings** and **Advanced Settings**.

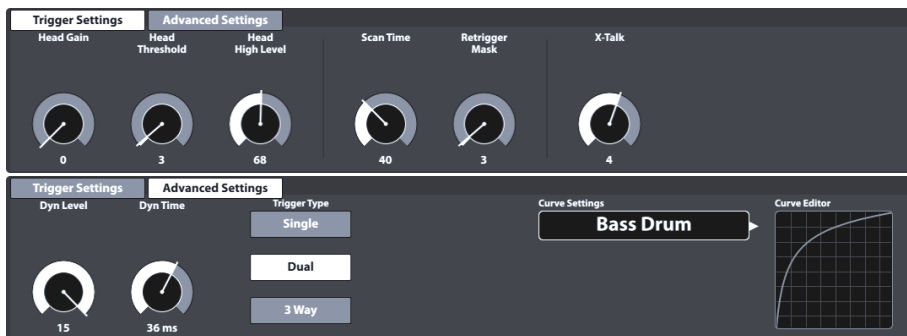

The following table lists all parameters available by component:

Trigger Parameters by Component										
Parameters				Components						
				Drums			Cymbals			
				Kick	Other					
Parameter Name		Unit	Value Range	Head	Head	Rim	Bow	Edge	Bell	HH Controller
Trigger Settings	Gain	Integer	0-8	•	•	•	•	•		
	Threshold	Integer	1-127	•	•	•	•	•	•	
	High Level	Integer	8-127	•	•	•	•	•		
	Scan Time	1/10 ms	10-100	•	•	•	•	•		
	Retrigger Mask		1-127	•	•	•	•	•		
	X-Talk		0-7	•	•	•	•	•		
	High Position		0-127							•
	Low Position		0-127							•
	Chick Sensitivity		0-127							•
Advanced Settings	Dyn Time	ms	0-60	•	•	•	•	•		
	Dyn Level		0-15	•	•	•	•	•		
	Splash Sensitivity		0-127							•
	Trigger Type									
	• Single			•	•		•			
	• Dual				•		•			
	• 3Way					Aux 1-3*	Ride*			
	• Piezo					•		•		
	• Switch					•		•		
	Positional Sensing					•				
Velocity Curves (Factory)				•	•	•	•	•	•	
Velocity Curves (Custom)				•	•	•	•	•	•	

* 3Way is a specialty of Roland™ analogue ride cymbals, where bell and other components are separated by their own plug/jack. When using these cymbals choosing the Ride input channel of the G9, Aux 1 will be automatically configured as Bell channel. Optional channels are Aux 1-3, where the following Aux channel is always defined as the bell channel. To this end, the Aux 4 is not suitable, due to the missing bell channel (which should be the non-existing Aux 5).

To gain a deeper understanding on how each parameter affects the detection of trigger signals, the following sections provide explanatory material. We will tackle each parameter following the order of the UI layout.

11.3.1 TRIGGER SETTINGS

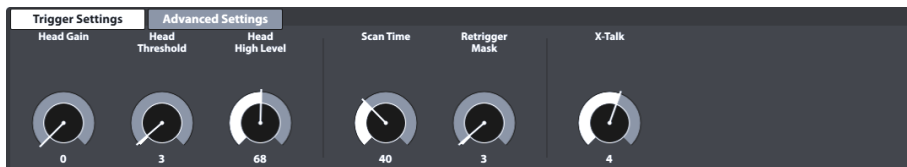

This is the first of the function sets containing trigger parameters. See the following sections for explanations and best practice approaches of each parameter.

11.3.1.1 GAIN

This is simply an amplification of trigger signals received before input. Some piezo ceramic elements available on the markets produce precise, but weak signals, which can be amplified by the gain feature before being recognized as input signal. The construction of the pad used can also contribute to weak signals.

Use this feature, if you are happy with the progression in velocity of your custom-built trigger pad and you feel that the overall volume produced cannot compete with other pads connected to your G9. This feature might come in handy when connecting 3rd party pads from other manufacturers as well.

Gain parameter values range from 0 (no amplification) to 8 (maximum amplification).

Low Gain values are recommended for taming pads producing high electrical signals and higher gain values are suitable for pads producing weaker electrical signals.

The following illustration demonstrates the effect of increasing the gain value given the same velocity progression in the **Pad Monitor** (module 4):

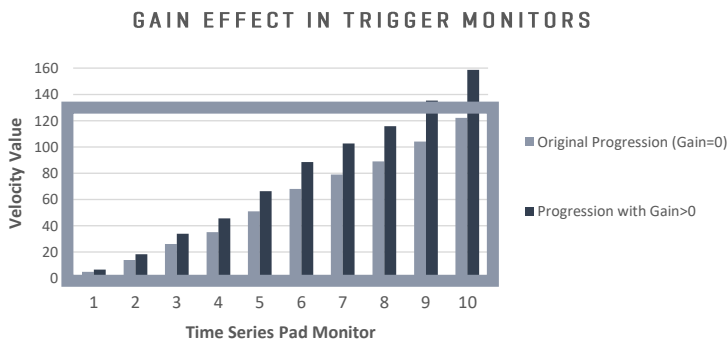

Gain multiplies the signal with a certain factor. Results above the maximum velocity of 127 will cause clipping, losing dynamics in the upper spectrum. Increase the gain slowly, until the response feels natural and the hardest hits produce velocity values of 127. Also keep in mind that it is hard to check dynamics, when the signal is weak. Understand **Gain** always in conjunction with the assigned **trigger curve**. Furthermore, set **High Level** values can produce a bias by compressing the range of input signals mapped to the velocity range of 0-127. The progression should feel like on an acoustic drum, unless you are going for different results.

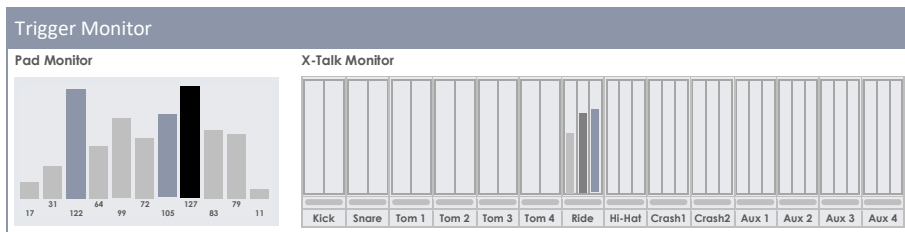

11.3.1.2 THRESHOLD

With this dial you adjust the velocity threshold from which on the G9 accepts signals sent by the detecting sensor (voltage). Low thresholds are preferable for sensitive players, but often cause auto triggering due to vibrations of the environment. Such signals are not desired since they produce sounds which don't stem from striking a pad.

The name threshold is always preceded by the name of the active component and it is available for almost every component, except for Bells (cymbals). Bell and edge sensors work in conjunction with each other and by adjusting the edge sensor, you automatically adjust the bell qualities.

Threshold parameter value range: 1-127

For piezo inputs: Input threshold level. Sets at what minimum (relative electrical) level a signal will be detected as a hit. This is one of the main settings affecting overall performance of the drum kit and the best actual value depends on types of pads used. It may take a while to find the best value.

For switch Rim/Edge inputs: Input Switch threshold. Sets below which level the switch is detected as hit/pressed. Note that on the switch Rim/Edge inputs actual velocity is derived from the piezo signal of the Head/Bow input. The best way to set a correct threshold on a switch input is to check the **Pad Monitor for Choke** messages. With a proper threshold value, you should see at least one Choke message when you press the switch. If detected, these Choke Messages appear as black bars with a constant velocity value of 127. Depending on the selected Trigger Type and the way pressure is applied to the sensor, you might observe more Choke messages. If you apply pressure to an FSR Sensor and don't observe Choke messages in Pad Monitor, then the Threshold needs to be adjusted. Try to explore the full Threshold spectrum to determine the boundaries between which you obtain Choke messages.

Bell Threshold is relevant for the for the 3rd zone of a 3 Zone Yamaha-style pad/cymbal. Sets below which level the Bell switch is detected as hit/pressed. This level must be lower than the Threshold level of the Rim/Edge input of a switch type trigger (**Edge Threshold**). If the connected pad is a 3Way Roland cymbal, **Bell Threshold** must be set to 0 to prevent false triggering of Bell notes.

How to proceed:

Strike components detected by piezo elements (e. g. head) as soft as you would normally play and start with the lowest threshold, rising it gradually until your softest strokes are not recognized in the **Trigger Monitor** any more. Then go back 1-2 steps in threshold again. This way you set the threshold as low as possible and as high as needed. Regarding **Switch** inputs the procedure works the other way around. Since switch type sensors already carry a low voltage permanently, the voltage goes down by pressing/activating the sensor. Increase the threshold gradually and select the highest threshold that still returns choke messages in **Pad Monitor**.

11.3.1.3 HIGH LEVEL

High (top) level of the input. In conjunction with the **Threshold** it sets the boundaries of the span of relative electrical signals to which the MIDI velocity value range (0-127) is mapped. Signals with relative electrical levels between Threshold and High Level will produce MIDI notes with velocities between 1 and 127. Any signals with relative electrical levels above **High Level** will produce MIDI notes with velocity 127. The further Threshold and High Level are apart the better, provided you can reliably get MIDI notes with velocity 127 for the strongest hits. Having said that, you will lose almost no dynamics until when **High Level-Threshold<25~38**. If you set High Level to maximum (127), and still easily get MIDI notes with velocity 127 you probably have a very 'hot' pad and you may lose hit dynamics. Try lowering **Gain**. If it doesn't help you will probably need to use a voltage divider on the input.

G9 High Level parameter value range: 8-127



Hint: The High Level value range of the G9 translates relative electrical signals into the MIDI Value range (0-127). Don't confuse this range with MIDI velocity. Depending on the strength of signals a pad produces it is possible to lower High Level below 127 and still reach velocities of 127.

11.3.1.4 SCAN TIME

Minimum scan time for the input. Measured/shown in 1/10th of millisecond. Can be set between 10 and 100 (1 - 10ms). When the G9 detects a signal above **Threshold**/Dynamic threshold, it will keep sampling it for the length of the set **Scan Time** Period before marking the signal as registered and making it ready to be sent via MIDI. Next, the G9 scans all Trigger Inputs for registered signals again.

The exact system latency (from stroke to sound) consists of the delay from sensor to input, 1 fixed millisecond for a non-editable Latency parameter (analysis trigger signals), the **Scan Time** parameter and the time for the resulting MIDI message to produce the sound in the sound engine. **Scan Time** and Latency describe the boundaries of minimum and maximum latency in trigger performance as follows: G9 trigger latency is at least Latency(1ms) and maximally Latency (1ms) + **Scan Time**.

Lowering **Scan Time** will improve latency and may worsen level accuracy. Raising it will worsen latency and may improve level accuracy.

Generally, for rubber type pads/cymbals setting Scan Time to 20 (2ms) is enough for proper signal level detection. For mesh-type pads you may need to raise Scan Time to 30-50 - the bigger mesh type pads the higher **Scan Time** is required for proper signal level detection.

Scan Time parameter value range: 10-100

11.3.1.5 RETRIGGER MASK

Retrigger period in milliseconds for the input. Determines how many milliseconds must pass after a previously detected signal for a new signal to be detected - to prevent a 'machine gun' effect or false triggering due to vibration after a hit. As a threshold setting this is one of the most important parameters and it may take some time to find the best value. Ideally it should be set as low as possible and let **Threshold** combat the 'machine gun' side effect as well as false triggering in first place. But if even with highest **Threshold** Levels and dynamic threshold decay times (**Dyn Time**) you still get these unwanted effects; you may need to raise the **Retrigger Mask** level. On **DIY** pads and cymbals, good Retrigger Mask values are in the range of approximately 4 to 12 milliseconds. Setting Retrigger Mask too high will prevent you from doing fast drum rolls.

Retrigger Mask parameter value range: 1-127

11.3.1.6 X-TALK

X-Talk is a tool to avoid triggering of unwanted signals caused by other pads in the immediate vicinity. When instruments are mounted on a rack or stands which have physical contact, playing on one instrument can cause shock-like vibrations. As a result, trigger sensors are activated in a more aggressive way than the impact of natural sonic waves would have on surrounding acoustic instruments. Consequently, surrounding instruments respond with sound whose volume is unnaturally high.

X-Talk allows you to set a **Threshold** for other triggers to respond to strokes on a certain pad, while velocity values below the set threshold are simply ignored by the analyzing unit (G9 Module). However, this practice comes at a price, since the physical impact of two instruments on each other is mostly mutual. High **X-Talk** thresholds work against low activation thresholds of individual pads (sensitive players) and any physical issue often requires rising the **X-Talk** values on both instruments causing the problem. Check your hardware first and try to avoid physical contact as much as possible before making use of the **X-Talk** feature.

X-Talk Parameter Value Range: 0-7

See the following section on how to work with **X-Talk**.

11.3.1.6.1 ADJUSTING X-TALK PARAMETERS

If despite the best possible hardware setup, a pad is activated by others, try to identify the source pad, sending unwanted MIDI signals using the **X-Talk Monitor**. Then raise the X-Talk value to at least one (1) on **both** pads (emitting pad and receiving pad). If the problem still occurs, raise the value gradually on the pad which receives unwanted signals. It is important that both pads have X-Talk values of at least one to make them a member of the X-talk group. High X-talk values on the pad experiencing disturbance will have no effect, if there is not at least one other connected pad with an X-talk value of at least 1. Only keep raising x-talk values on pads experiencing problems. The goal is: as low as possible, and only as high as required to suppress viral MIDI signals.

11.3.1.7 HIGH POSITION (HI-HAT PEDAL ONLY)

Set the High Position of the Hi-Hat Pedal, when pedal is fully open (released). If set too high you may not be able to access the Sound Sample Layers for fully opened Hi-Hat Cymbals, even if the Cymbals are spaced apart completely (resting position).

Ideally you adjust **Low Position** and **High Position** in a way that the values are as far apart as possible and yet pedal/controller reach extreme positions. Use the VU Meter **Pedal Position** (not very accurate) or CC messages visible in **Pad Monitor**. When using Pad Monitor CC messages as a guidance you need to achieve such a configuration that CC messages are not sent by the G9 in extreme pedal positions.

High Position Parameter Value Range: 0-127

11.3.1.8 LOW POSITION (HI-HAT PEDAL ONLY)

Set the low level of the pedal, when pedal is fully pressed, and the cymbals are in closed position. This corresponds to the lowest possible position the controller carrier will reach. If **Low Position** is set

too low you may not be able to get fully closed Hi-Hat Sounds, even if the cymbals are in closed position with a good amount of pressure on the Hi-Hat Pedal.

Low Position Parameter Value Range: 0-127

11.3.1.9 CHICK SENSITIVITY (HI-HAT PEDAL ONLY)

Measured against CC MIDI message value: 0 - for fully open, 127 - for fully closed. Set the level below which a following pedal 'step on' will generate a chick.

Chick Sensitivity Parameter Value Range: 0-127

11.3.1.10 PEDAL CALIBRATION (HI-HAT PEDAL ONLY)

This function sets the values for **Low Position** and **High Position** by using a calibration wizard. Instead of trying out different values individually, this guided process will be especially useful in conjunction with 3rd party equipment, providing a good first estimate about the value range in which the equipment operates. Since Low Position refers to a closed position with maximum pressure and limited musical application, the routine will automatically define the closed position with less pressure at an offset of 15% above the determined **Low Position** value. After the calibration, some minor manual adjustments of the Low Position parameter might be necessary to compensate characteristics of different gear ratios between pedal and the Hi-Hat rod.

The following table explains the calibration wizard:

G9 Hi-Hat Calibration

Graphic Elements

Hints

1



Tap the Hi-Hat Pedal icon in module 2 to select the Hi-Hat Controller/Pedal.

2



Tap the **[Calibrate...]** button in module 3

3

Hi-Hat Calibration

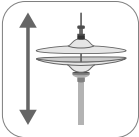

High Position
109

Low position
90

With this dialog you can calibrate the parameters Low Position and High Position of your HI-Hat Pedal. For best results follow the instructions step by step.

Tap **[Next]** to start the calibration.

Cancel Next

The start screen with a short explanation

Tap **[Next]** to start the calibration.

4

Hi-Hat Calibration

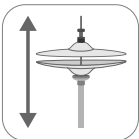

High Position
109

Low position
90

Low Position
Press the pedal all way down and tap **[Calibrate]**. After that tap **[Next]**.

Calibrate

Cancel Next

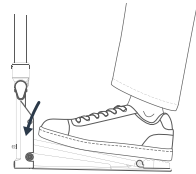

Apply **STRONG** pressure (as you would do for tight Hi-Hat sounds) before tapping **[Calibrate]**

5

Hi-Hat Calibration

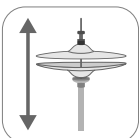

High Position
109

Low position
84

High Position
Release the pedal completely and tap **[Calibrate]**. After that tap **[Finish]**.

Calibrate

Cancel Finish

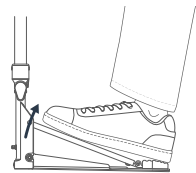

Release the pedal completely or remove the foot before tapping **[Calibrate]**

11.3.2 ADVANCED SETTINGS



This is the second of the function sets containing trigger parameters. See the following sections for explanations and best practice approaches of each parameter.

11.3.2.1 DYN LEVEL & DYN TIME

Dynamic Threshold level and Dynamic Threshold decay time for the input. Also, two very important parameters. Raising both **Dyn Level** and **Dyn Time** will tell G9 to suppress false triggering harder (crosstalk between inputs and double triggering). Raising them too high may cause the G9 to miss some hits on fast/press rolls. **Dyn Level** sets how hard the G9 will try to suppress false triggering. **Dyn Time** sets for how long false triggering will be suppressed. For most rubber type pads/cymbals **Dyn Level** between 8 and 15 and **Dyn Time** between 8 and 20 should produce the best results. For mesh type pads it may be necessary to raise **Dyn Time** above 20 and up to 60. The bigger the Mesh Head diameter, the higher **Dyn Time** values are required.

GEWA Trigger Trays by design should produce best press rolls with **Dyn Time** values between 8 and 10.

Dyn Level parameter value range: 0-15

Dyn Time parameter value range: 0-60 ms

11.3.2.2 SPLASH SENSITIVITY (HI-HAT PEDAL ONLY)

Sets the number of milliseconds the G9 will wait before sending a **slash note**, when you execute a **splash**. It can be set to any value above 0. If you set it to 0 you can only get **Chicks** (splash is off). The higher the **Splash Sensitivity** the easier it is to get "splashes" but the longer are the delays for their detection. If set it too high (15-30 milliseconds) you might begin noticing **splash latency**.

Splash Sensitivity parameter value range: 0-127

11.3.2.3 TRIGGER TYPE

The trigger type allows for communication with various types of pads of different manufacturers. The options available vary with the selected component. Not all combinations are possible. In case of "Single" settings for Rim/Edge and Bell will be ignored.

Trigger Type by Component		
Head/Bow	Rim	Edge
Single	Piezo	Switch
Dual (Default GEWA)	Switch	
3Way (GEWA option)		

Single:

Head/Bow and Rim/Edge are treated as two different pads. An application would be a simple single zone pad with single piezo triggering.

Dual:

Sets the Head/Bow Channel up in a way that Rim/Edge signals are expected to use the same Input Channel as Head/Bow. In combination with this choice you must also specify, how the Rim/Edge signals are detected (Piezo or Switch). Change to the other components by tapping on the component icons and check your settings for every input channel.

All GEWA pads work as **Dual** pads with **Piezo** detection for **Rims** and **Switch** for **Edge** and **Bell**.

The latter is set to switch automatically and activates as such, as soon as you assign a cymbal trigger bank to an input channel and chose Dual for Bow and Switch for the Edge.

3Way:

This is a specialty regarding cymbals. Some manufacturers separate the Bell channel from the rest, allowing for an individual velocity curve on Bells. GEWA cymbals support both methods (Dual and 3Way). Select 3Way for Bow components and switch for the Edge component. As a result, the Bell is configured as switch automatically and the input channel next to the Bow/Edge input channel will be reserved for the Bell. Connect this jack with a ¼" TRS cable to the outer jack of your GEWA Cymbal. For further information on connecting cymbals and all possible pairs of input channels using 3Way, see section 3.2.3 Cymbals on p.12.

Piezo and Switch:

These options are available for Rim/Edge/Bell components only and follow the type of trigger used. For pads with 2 piezos for triggering Head and Rim, choose **Dual** for the **Head** and **Piezo** for the **Rim**. Cymbals mostly utilize an FSR film for the detection of Bell/Edge and Choke. Choose **Switch** for the edge component, while the **Bow** can either be set to **Dual** or **3Way**.

11.3.2.4 CURVE SETTINGS

Even if the sound samples of consecutive velocity layers are recorded in a linear fashion, most contemporary trigger methods follow a concave progression in detection of signals. This means that even if you increase the velocity of a stroke linearly, the trigger method will return a velocity value that follows a non-linear path. This skew in detection needs to be corrected, so that the software picks a set of sound samples which matches the intensity of stroke in real world. To this end, the G9 ships with a limited number of curves representing different degrees of detection skews. Choosing adequate velocity curves depends on the choice of components of different manufacturers (technical specifications) and the personal expectations in sound progression of the player. The **Presets** provided are curves optimized for pads using the GEWA Trigger Trays and Cymbals and the preset curves provided already compensate this effect to a certain degree, so that they appear less bend in the Interface, maximizing the possibilities of customization. Not only does the standard curve have a linear appearance, it is also designed to return a linear feel in audible dynamics.

The following section tackles the assignment of preset curves.

11.3.2.4.1 ASSIGNING PRESET CURVES

Proceed as follows:

1. Select an **Input Channel** in Module 1 (Pad).

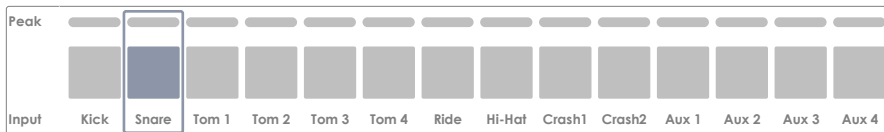

2. Select a component to edit by tapping the corresponding icon in module 2 (Trigger Selection).



3. Tap the function set **Advanced Settings** in module 3.
4. Tap once on the **[Curve Settings]** field.



5. Select one of the curves in the **Presets** or **User** column by double tapping.

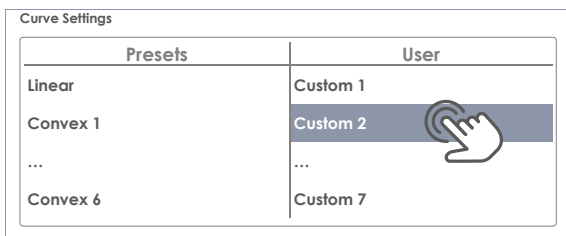

6. Save your changes by doing one of the following:
 - a. Directly in a **Trigger Set Up**:
 - i. Tap the **Setup** field (module 2).



- ii. Highlight a user Setup where you want to store the curve and tap **[Save]**. Alternatively tap **[New]** in the Feature Shelf to create a fresh Setup.

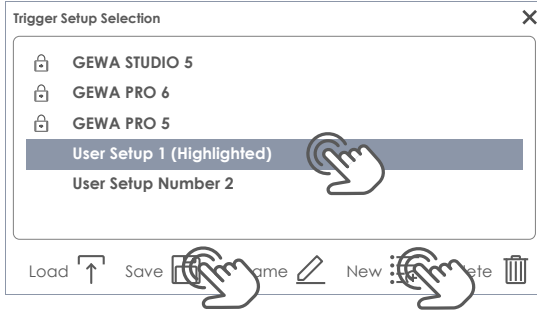

- b. As a **Trigger Bank** (Preset indirect):
 - i. Tap the **Trigger Bank** field (module 2).

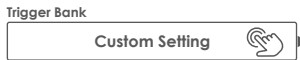

- ii. Select a User Trigger Bank in the drop-down list and tap **[Save]** to overwrite the highlighted entry. Alternatively tap **[New]** to create a new Trigger Bank with current parameter values visible in the User Interface.

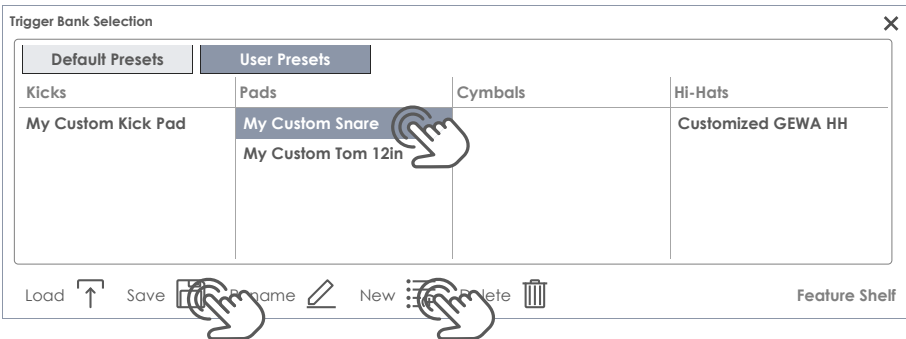

The following table shows the drop-down list which opens by tapping the **Curve Settings** field:

Curve Settings	
Presets	User (Editable)
Linear	Custom 1
Convex 1	Custom 2
Convex 2	Custom 3
Convex 3	Custom 4
Convex 4	Custom 5
Convex 5	Custom 6
Convex 6	Custom 7
Concave 1	
Concave 2	

Note: Trigger curves work on a pad component level. Assigning a new curve will only affect the active component (Head, Rim, etc.) in module 2 of the selected pad under input channels (module 1). Make sure that the correct pad component is activated (tap on its icon) and repeat the process for the remaining components if necessary. If you can't find a curve among the preset curves provided that satisfies your expectations, you have the option of design **up to 7 custom curves**. For more information please refer to the following section.

11.3.2.5 CURVE EDITOR

Next to the preset curves you can create and fine tune your custom trigger curves. These curves are specific to the component selected (e.g. Bell or Head). That means you can adjust the velocity curve of components independently from each other. The choice of the curve type depends on how voltage generated by the sensor progresses with the velocity of the stroke. With this feature, the G9 allows for compensation of different trigger detection methods and sensor types from various manufacturers. In the acoustic world the relation between volume and velocity of strokes is typically linear, but the relation between the voltage generated by the sensor depending on the stroke velocity is typically concave. That means that without any compensation, the trigger board would constantly address Sample Layers from the sound bank that were recorded at lower stroke velocities. Soft strokes would sound unnaturally quiet with an unnaturally low increase in volume while executing a **crescendo**.

The function of a hull curve is simply to offset the errors caused by the sensor and bring the detection of signals in harmony with the acoustic world, so that those sample layers are drawn from the sound bank that match the intensity of the stroke.

With this knowledge we know, that an adequate compensation of detection skews must be typically convex, although the real characteristics of a certain sensor are unknown. Even the way how a piezo is attached to the hardware can alter the detection curve drastically. Therefore, finding the perfect compensation curve is always a matter of trial and error.

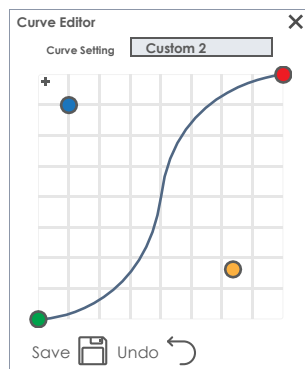

11.3.2.5.1 CREATING CUSTOM CURVES

1. Select an **Input Channel** in Module 1 (Pad).



2. Select a component to edit by tapping the corresponding icon in module 2 (**Trigger Selection**).



3. In the the function set **Advanced Settings** (Module 3) tap once the **[Curve Settings]** field.



4. Select one of the curves in the **User Presets** column by double tapping.

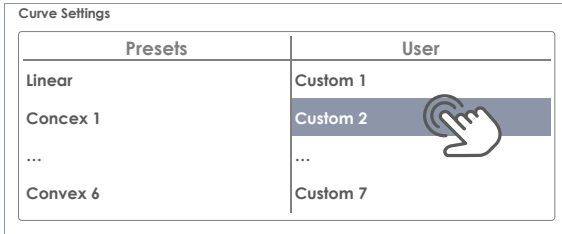

5. Tap the field **[Curve Editor]** once in the function set **Advanced Settings**.

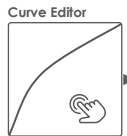

6. Edit the curve by dragging the dots and check effects by playing on the pad component.

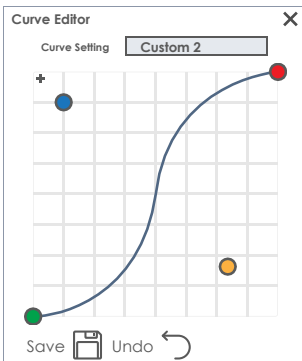

7. (Optional) Add/remove another control point by tapping **[+]**.
8. (Optional) Rename the curve by tapping the field **[Curve Setting]** to open the keyboard.
9. Tap **[Save]** in the Curve Editor to store the new curve shape.
10. The curve itself is a preset which will only take effect if it is assigned to a trigger bank preset or setup. Curves that are already assigned to higher trigger preset orders will update in trigger banks and setups immediately after saving the curve shape (step 9). In this case the following steps are optional. Proceed as follows:
 - a. Storage directly in a Trigger Setup:
 - i. Tap the **[Setup]** field (module 2).
 - ii. Highlight a user setup tapping once on the list entry and Tap **[Save]** in the Feature Shelf to update the setup. Alternatively tap **[New]** to create a fresh setup for your pad configuration.



- b. Storage as Trigger Bank (indirect):
 - i. Tap the **[Trigger Bank]** field (module 2).
 - ii. Highlight a User Trigger Bank by tapping once on the list entry and tap **[Save]** to update the Trigger Bank. Alternatively tap **[New]** to create a fresh **Trigger Bank** for your pad.



i *Hint: Modifying, renaming and saving already assigned user curves will not result in a "Custom Setting" in the Trigger Bank field. Instead, the trigger bank name is retained, and saved changes in curve shapes will update accordingly in every setup or trigger bank the curve is assigned to. In this case you don't need to save the trigger bank separately.*

i *Note: Only custom trigger curves are editable!*

Useful functions of the curve editor dialog:

Curve Editor – Feature Shelf



Undo (Returns to the initial curve shape before opening the Curve Editor)



Save (Saves the curve points as seen in the UI)

11.4 MODULE 4

11.4.1 TRIGGER MONITOR

Trigger Monitor

Pad Monitor

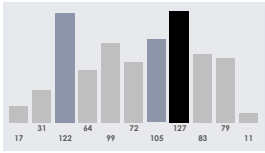

X-Talk Monitor

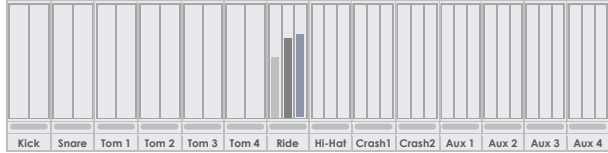

In this module you will find all visual monitors tracking the input signals of each pad component. Results are mostly visualized by colors, which change depending on the active **UI Theme** (check **General Settings** → **Module 4** → **Device** → **UI Theme**).

Color schemes for Trigger Monitors are chosen as follows:

Colors Trigger Monitor by UI Theme

		Head Bow	Rim Edge	Bell	Choke
UI Theme	GEWA Red GEWA Classic GEWA White Tritanopia	[Red]	[Yellow]	[Teal]	[Black]
	Deutanopia Protanopia	[Blue]	[Yellow]	[Teal]	[Black]
	Grayscale	[Dark Gray]	White	[Medium Gray]	[Black]

See the following sections to learn about the functioning of each monitor, so that you can interpret them.

11.4.1.1 PAD MONITOR

Monitors all registered signals of the **Input Channels** by returning the stroke velocity in the standard MIDI range of 1 to 127. A time series of the last 10 strokes is displayed in the viewport. Detected head strokes and rim strokes are distinguished by the color of the bars and depend on the **UI Theme** chosen. See the color table in the previous section for reference. The actual velocity value of a stroke is shown at the bottom of each peak and visualized by the height of the bar.

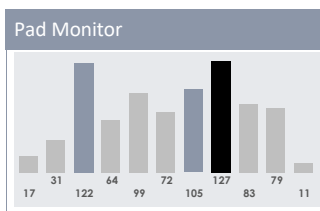

The pad monitor is useful for detecting whether a pad is maxing out at moderate strokes already, or a pad is causing barely audible double triggering.

To sum it up, the pad monitor gives valuable real-time feedback about the communication between the G9 and its connected pads.

11.4.1.2 X-TALK MONITOR

The Crosstalk Monitor detects every signal of each pad sent to the G9 while playing. Its main purpose is to observe trigger signals sent by pad components you haven't hit at all. Often vibrations travel through the hardware and cause accidental activation of other sensors (X-Talk). Striking a certain component should only activate the sensor responsible for that very component. Check your hardware set up, if you activate more channels or components, than those you are playing. As opposed to the Pad Monitor, the X-Talk Monitor gives feedback about the last stroke only.

Apart from peak meters for components, the X-Talk Monitor tracks the highest peak of an input channel while playing, represented by a fine bar between pad name (input channel) and peak meters. Examine your trigger settings in case of these bars lighting up in peak colors although you are playing moderately. Maximum peaks are visible for about 5 seconds after the last detected input signal. After this period, the X-Talk Monitor clears all values, resulting in a blank monitor screen.

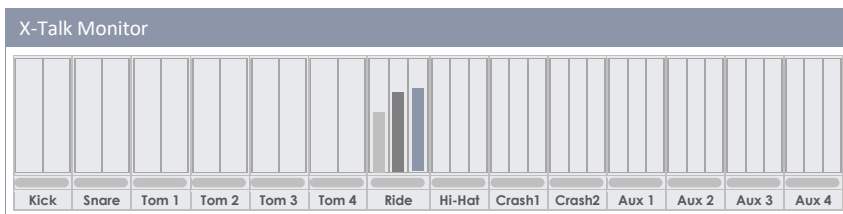

12 GENERAL SETTINGS



All adjustments made in this mode affect device specific parameters, which are stored globally and memorized on next start up. Here you will find more options such as controls for **Master Outs**, **Direct Outs** and **Digital Outs** including equalizers and compressors. You can also control the **routing of pads** and the **routing of other input signals**. Routing is a very powerful tool which allows for sending any input signal to any output channel of your choice, including everything from headphones to industry standard DAWs like Cubase, Pro Tools and Logic Pro. Control critical aspects of sound by yourself and send selected signals to the audio engineer by using the **routing matrix**.

Furthermore, you can assign external controls such as foot- or pad switches to trigger certain events inside the interface.

Module 3 manages everything related to MIDI implementation, whereas module 4 host device specific features such as Bluetooth and Wi-Fi. Consult this module also for firmware updates, factory resets and the download of manuals without the need of visiting external websites.

The screenshot displays the General Settings interface, organized into several sections:

- Metronome:** Tempo set to 90 bpm.
- Master Outs:** Controls for Master Out, Direct Outs, and Digital Outs, including Volume and Balance knobs and peak meters.
- Routing Drums / Routing Others:** Controls for Phones, including Volume and Balance knobs and a peak meter.
- Monitor Out:** Includes Master Equalizer (set to Linear), Headphone, Monitor Outputs, and Master Compressor (set to Default 1).
- MIDI:** Global MIDI Settings (Soft Thru), MIDI Input, MIDI Control, and Drum Kit Program Change settings.
- Device:** Controls for Wifi, Bluetooth, Factory Reset, Information, and Update.

A vertical sidebar on the right contains icons for Performance, Kit Editor, Effects, Trigger Settings, General Settings, Tools, and Preview.

12.1 MODULE 1

This module controls global properties for all standard outputs offered by the G9 Workstation. Next to exclusively stereo outputs like **Master Outs** you can manage **Direct Outs**, which function as Dual Mono or Stereo depending on your choice. On the other hand, the function set **Digital Outs** provides controls for the amplification or reduction of digital audio signals. The activity of each output is monitored via the corresponding peak meters. Peak meters are activated by playing on pads, playing a song via Bluetooth or Song Player if these inputs are assigned to the output of interest in the **Routing Matrix**. Check the tabs **[Routing Drums]** and **[Routing Others]** to see whether the nodes are checked for a pair of Input and Output.

12.1.1 MASTER OUTS



This function set provides adjustments for the standard outputs of the console such as **Master Outs** (XLR, S/PDIF), **Monitor Outs** or **Phones**. The volume dials are instances of the corresponding hardware dials on the left-hand side. Consequently, values of the hardware dials will update when adjusting the volume of an output in **Master Outs**. The **Balance** dials however can only be found in this location, allowing for correcting acoustic properties of the environment or connected hardware. L/R Buttons in this function set have only informative character. As mentioned above, these outputs are exclusively stereo.

The following tables show the ports addressed by the adjustments made in this function set:

Ports – Master Out

-  XLR – L (analog)
-  XLR – R (analog)
-  S/PDIF – Stereo (digital)

Ports – Monitor Out

-  1/4" (6,35 mm) TS – L (Mono)
-  1/4" (6,35 mm) TS – R (Mono)

Ports – Phones (Front Panel)

-  1/4" (6,35 mm) TRS – Stereo

12.1.2 DIRECT OUTS

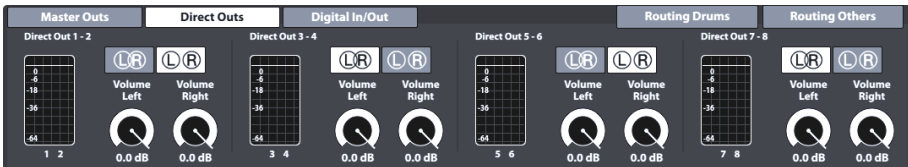

Adjustments of **Direct Outs** work in the same way as **Master Outs**, but with the exception that **Direct Outs** can be configured as either **Dual Mono** outputs or **Stereo** outputs. The choice in configuration will take effect in the routing matrix **Routing Drums** (see 12.1.4 *Routing Drums & Routing Others* on page 107).

To be able to handle Dual Mono configurations, the 8 individual Mono Outs are arranged in groups of two (**1 - 2, 3 - 4, 5 - 6, 7 - 8**). A second L/R icon is added to each group. In Direct Outs L/R icons are interactive and function as buttons to switch between Dual Mono and Stereo configuration. Icons and their meaning:

Direct Outs - Configurations	
	Stereo Configuration
	Dual Mono Configuration

In the Dual Mono world balance dials are obsolete, therefore volume and balance dials are replaced by two individual volume dials (**Volume Left, Volume Right**). This allows for independent volume adjustments in Dual Mono settings, while in a Stereo configuration you can balance out left and right speakers by tweaking values of the individual volume dials in relation to each other.

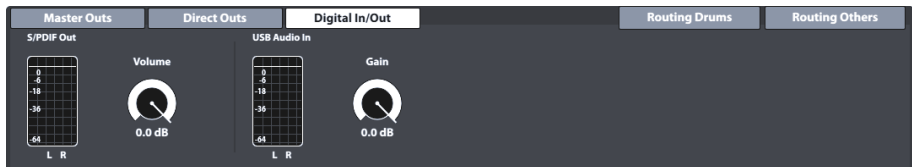

Ports – Direct Outs (Rear Panel)
 1/4" (6,35 mm) TS (Mono)

12.1.3 DIGITAL IN/OUT



This function set controls the volume of the digital audio connections. Note that USB Audio can be used next to the occupation of the USB port as MIDI. Audio and MIDI Data can flow at the same time. The logarithmic faders allow for digital attenuation of signals within a range between $-\infty$ dB (max) to 0 dB (min).

See the following table for ports addressed by the adjustments in this Function Set:

Ports – Digital In/Out	
	S/PDIF – Stereo Output (digital)
	USB-MIDI – Bidirectional (In + Out), USB Audio In

12.1.4 ROUTING DRUMS & ROUTING OTHERS

You can send any input signal to a variety of output channels built into the G9 by utilizing the **Routing Matrix**. In this section you will learn how to edit, save, load, rename and delete matrix layouts. This is very useful if you are working in several studios or venues. Once you return to a studio or mixing desk, you can adapt your G9 to the given circumstances in just a few taps and recall the work settings stored before.

The G9’s routing function is divided into 2 input categories: **Routing Drums** and **Routing Others**. While their routable channels vary, the functionality and appearance are the same. Thus, the contents of the following subchapters apply to both input categories likewise.

Tap the routing buttons in the upper right corner of module 1 to open the corresponding **Routing Matrix**:

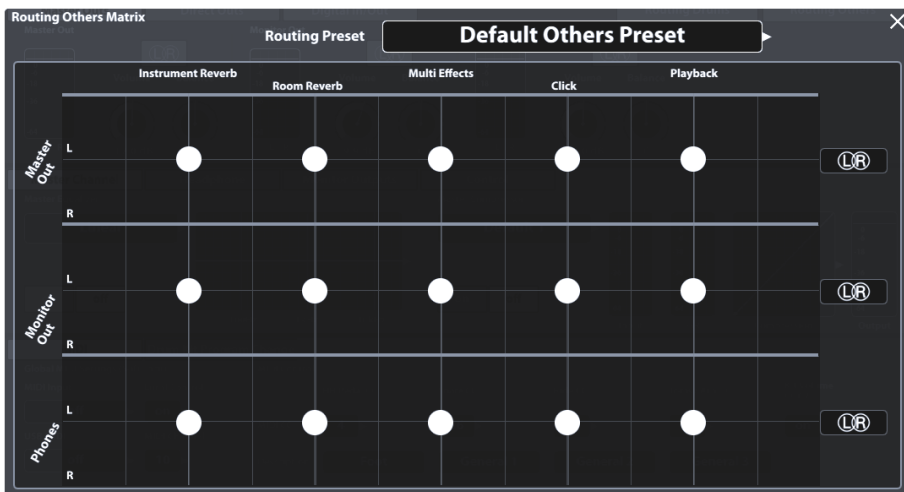
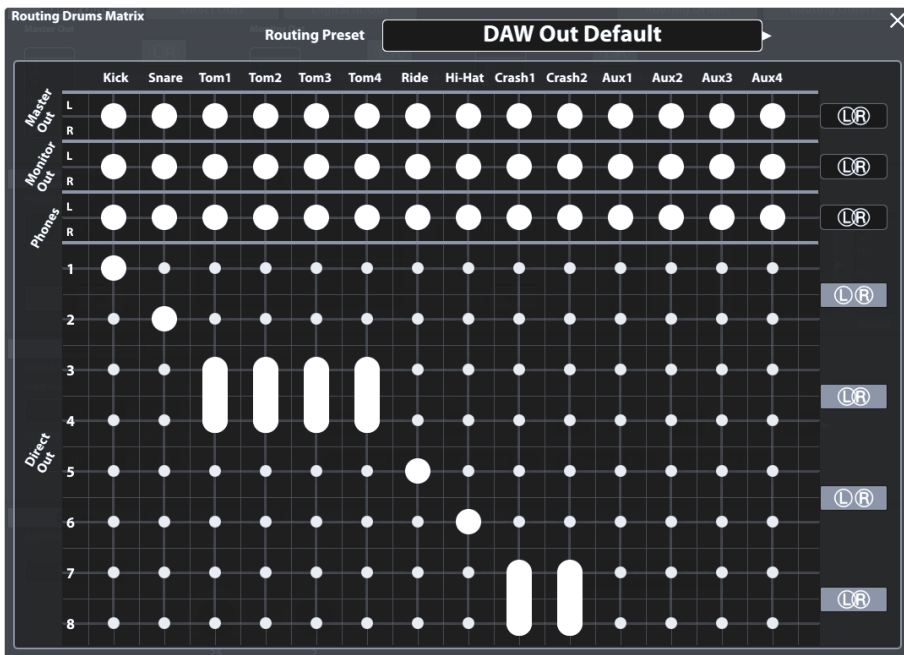

12.1.4.1 EDITING THE ROUTING MATRIX

1. Tap on **[Routing Drums]** or **[Routing Others]** to open the corresponding Routing Matrix.

Note that the **Input Channels**, effects and routable sound sources (Pads in particular) are arranged horizontally (Columns), whereas the available **Output Channels** are arranged vertically (Rows). Big dots indicate in which output an Input channel is audible and small dots show channels which are muted in the Mix sent to an output.

2. **Remove** an input channel from an output by tapping the big dot at the point of intersection of input column and output row.
3. **Add** an input to an output channel by tapping the small dot at the point of intersection of input column and output row.

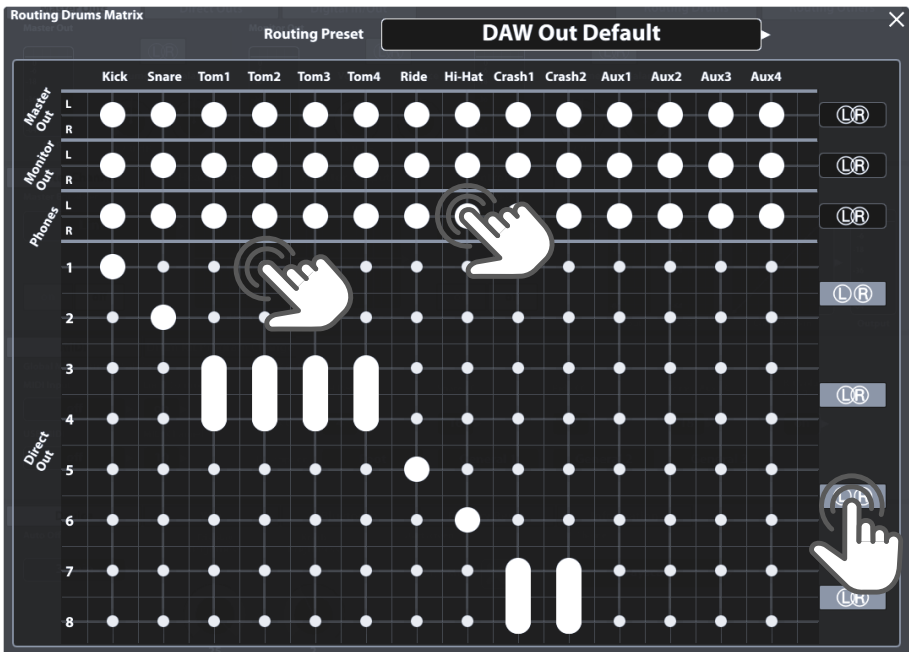

Direct Outs (Routing Drums) are special in a way that you can bind them together to a stereo output. Instead of 8 Mono outputs, you have the option of at most 4 stereo outputs. The L/R icons on the right-hand side of the routing matrix inform you about the current state. Intersection of the circles stands for stereo, whereas circles without intersection indicate a Mono configuration. A thick line will be drawn between the dots when adding an input channel to combined **Direct Outs** (stereo). L/R icons for direct outs are switchable in the routing matrix, too. Change mono/stereo settings of the Direct Outs by simply tapping the according buttons in the routing matrix, or:

1. Close the Routing Matrix and go to **General Settings** → **Module 1** → **Direct Outs**.

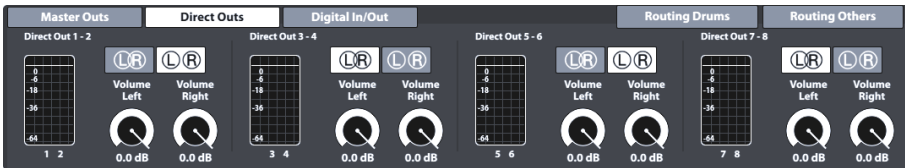

2. Switch between the L/R icons by tapping on the corresponding button.
3. Open the Routing Matrix again and check the state of the L/R icons on the right-hand side.

Direct Outs - Configurations

Stereo Configuration

Dual Mono Configuration





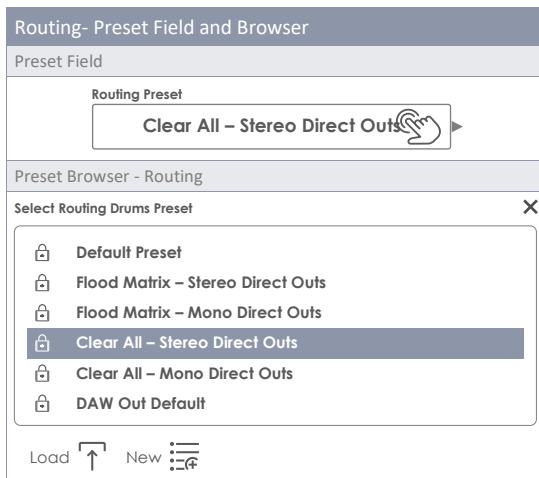



12.1.4.2 PRESETS – ROUTING

The G9 provides a variety of options to manage preset libraries. You can access the library and its functions by tapping on a **[Preset]** field next to a group of preset parameters. In the drop down, that open by tapping on a preset field, the G9 differentiates between **Factory Presets** (preceding lock icon) and **User Presets** (without lock icon).











Regarding user presets, the palette of options is extended, since factory presets are not editable. To see the difference between both types, highlight them one after the other by tapping once on the corresponding list entry in the preset browser.

See the following table for comparison:

Preset Management -Feature Shelf					
Preset Type	Function				
	Load	Save	Rename	New	Delete
 Factory Preset					
User Preset					

Factory presets provided serve as a starting point to avoid time consuming edits of about 100 dots manually. Chose the preset that brings you closest to the desired routing design and selectively alter the settings where needed.

The following table gives an overview over the **Factory Routing Presets**:

Factory Presets - Routing	
Routing Drums	
 Default Preset	All inputs activated for all standard outputs. Direct outs are completely muted (stereo configuration).
 Flood Matrix – Stereo Direct Outs	Activates every input channel for every output and configures direct outs completely as 4 stereo outs.
 Flood Matrix – Mono Direct Outs	Activates every input channel for every output and configures direct outs completely as 8 dual mono outs.
 Clear All – Stereo Direct Outs	Mutes every input channel in every output and configures direct outs completely as 4 stereo outs.
 Clear All – Mono Direct Outs	Mutes every input channel in every output and configures direct outs completely as 8 dual mono outs.
 DAW Out Default	Default preset with DAW configured direct outs: 2 stereo groups for toms and cymbals and 4 mono configurations for kick, snare, ride and hi-hat.
Routing Others	
 Default Others Preset	Activates every input for every output.
 Click on Headphones only	Removes the metronome from all outputs but the headphones.

The following sections discuss the functionalities of the feature shelf.

12.1.4.2.1 LOADING PRESETS

Proceed as follows:

1. Tap on the **[Routing Preset]** field.
2. Tap once on the preset you want to load.
3. Tap **[Load]** in the Feature Shelf.

The dialog closes automatically, and the new preset is active.

12.1.4.2.2 SAVING NEW PRESETS

In preparation please check whether the **Routing Preset** field contains the name **"Custom Setting"**. This indicates that values have changed and differ from those stored in the device database.

With **Custom Setting** visible proceed as follows:

1. Tap the **[Routing Preset]** field.

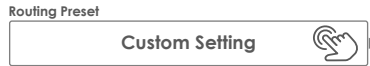

2. Tap **[New]** in the Feature Shelf.
3. Name your preset using the keyboard.
4. Confirm by tapping **[OK]**.

12.1.4.2.3 OVERWRITE PRESETS

You can overwrite user presets with current values set in the interface. This function is not available for factory presets (preceding lock icon).

1. Tap in the **[Routing Preset]** field.



2. Tap on the preset name to be overwritten.
3. Tap **[Save]** in the Feature Shelf.

12.1.4.2.4 RENAMING PRESETS

Renaming a preset will affect the preset name only and retain individual parameter values. This option is only available for user presets (without preceding lock icon).

1. Tap the **[Routing Preset]** Field.
2. Tap once on a preset name in the drop- down list.
3. Tap **[Rename]** in the Feature Shelf.
4. Enter a new name for the preset using the keyboard.
5. Confirm by tapping **[OK]**.

12.1.4.2.5 DELETING USER PRESETS

This function is not available for factory presets (preceding lock icon).

Proceed as follows:

1. Tap the **[Routing Preset]** field.
2. Tap once on a preset name in the drop-down list.
3. Tap **[Delete]** in the Feature Shelf.

12.2 MODULE 2

The second module of the General Settings mode hosts **Equalizer** and **Compressor** features for outputs as well as **Control** settings for peripheral devices such as **Foot Switch** pedals or control via a pad using an AUX input channel.

12.2.1 MASTER CHANNEL | HEADPHONE | MONITOR OUTPUTS

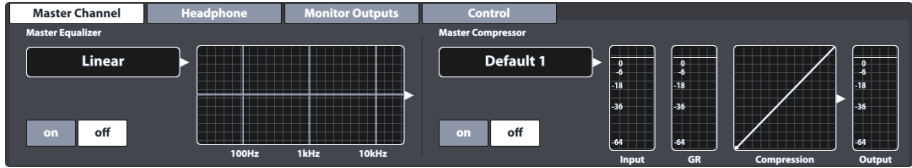

All Outputs in this module provide a 4-band full parametric equalizer and compressors that function in the same way. Therefore, we will discuss both features exemplary. Repeat the steps presented for each output if necessary and take advantage of the preset function to quickly share settings between different output types. Best results are obtained with basic knowledge in audio engineering and we recommend research of resources that cover this topic more in depth. This section will focus on the functions provided to edit the audio mix sent to the outputs of this module.

12.2.1.1 EQUALIZER

The equalizer function mainly serves to remove unwanted signals from the audio mix, such as frequencies that may cause microphone feedback in the recording environment. Since every environment is different, the need of correction and the edits required vary significantly depending on the situation. Consequently, the G9 only provides a constant linear factory preset for output channels which serves as a starting point. Recurring settings can be remembered by saving out user presets. This way you avoid repeating the editing steps when returning to a known environment or venue. The curve, that is modified by the accessible parameters displays the result of combined effects applied to the mix. **Pad Equalizers (3-Band)** are implemented as **Insert**, so that the sound of each pad can be shaped individually. The Insert property makes them audible in **Direct Outs** as well.

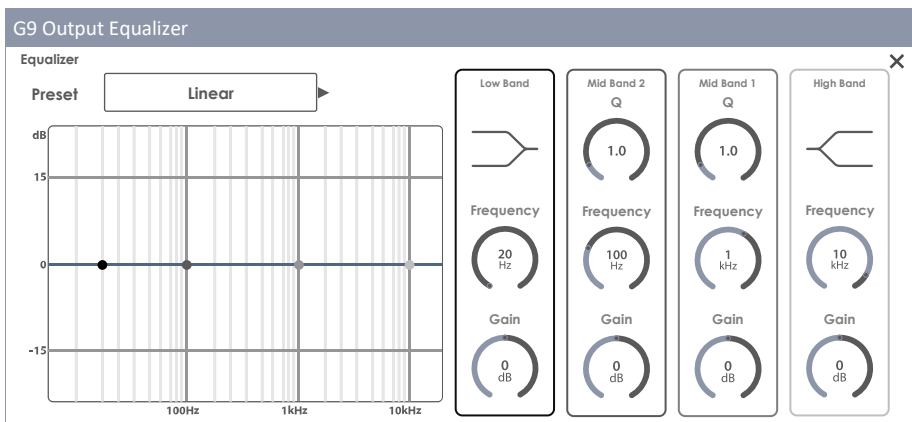

12.2.1.1.1 PARAMETERS AND DESCRIPTION

Equalizer - Parameters per Band					
Parameter	Value Range/Unit	Low Band	Mid Band 2	Mid Band 1	High Band
Shelving	---	●	---	---	●
Q Factor	0,1 – 8,0	---	●	●	---
Frequency	20 Hz -16 kHz	●	●	●	●
Gain	-15 dB – +15 dB	●	●	●	●

Equalizer – Description of Parameters	
Parameter	Description
Shelving	Attenuates or boosts frequencies above (High Band) or below (Low Band) a specified Shelf Frequency by the Gain Value.
Q Factor	Determines the band width or precision of the filter. Set the curvature around the edit point and consequently the width for neighboring frequencies to be affected. Low values result in sharp curvature and high values cause smoother transitions between the edit points and a broader spread of the spectrum affected by Gain .
Frequency	The frequency (mean) affected by the gain parameter. Regarding Shelving, this is the turning point in curvature.
Gain	Boosts or attenuates the set band Frequency (mean) by the amount of Gain dB adjusted. Neighboring frequencies get affected by the dB value of the Filter curve at this frequency.

12.2.1.1.2 EDITING EQ CURVES

Proceed as follows:

1. Turn Equalizer **[on]**.
2. Tap the **[Equalizer]** field which contains the editing curve.
A dialogue pops up giving you access to the EQ Parameters which modify the **Curve Points**.

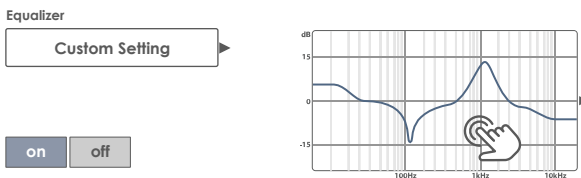

3. (Optional) Select a preset as starting point by tapping the **[Preset]** field.
Chose a preset by double tapping (alternatively: tap once on the preset name followed by a tap on **[Load]**).
4. Determine the frequency band that is closest to the disturbing frequencies in the audio mix.

5. Activate the matching frequency band on the right-hand side by tapping once on its parameter bar.
6. Note that you can access the parameters and manipulate the associated **Curve Points** in 3 alternative ways:
 - a. By tapping directly on a dial in the parameter bar
 - b. By turning the hardware dials assigned each parameter
 - c. By tapping on one of the upper three software dials next to the hardware dials
7. With the correct band activated, navigate to the middle of the problematic frequency spectrum by modifying the **Frequency** parameter. This will move curve points horizontally.
8. Modify the **Gain** parameter to adjust the desired amount of correction. This will move curve points vertically.
 - a. Decrease Gain values to mute the frequency set within the audio mix.
 - b. Increase Gain values to enhance the frequencies below the active curve point.
9. Modify the precision of the edit by manipulating the **Q** parameter (Mid Bands only). This will manipulate the curvature around the assigned curve point.
 - a. Increase the Q value to have the correction take effect in a narrow span around the chosen frequency value.
 - b. Low Q values will widen the frequency range to be affected.
10. Repeat steps 3-9 with the other frequency bands if necessary.
11. (Optional) Save changes depending on the equalizer type:
 - a. **Pad Equalizer (3-Band)**: By saving the drum kit (direct) or saving an EQ preset (indirect).
 - b. **Output Equalizer (4-Band)**: By creating a new EQ preset. (Output equalizers are no drum kit parameters!)

12.2.1.2 COMPRESSOR

While the **Equalizer** allows for shaping sound by addressing certain frequency ranges selectively, compressors will take effect across the whole frequency spectrum. In the G9, Pad Compressors are implemented as **Insert** type Compressors (**Input Channels** in **Kit Editor**), so that the sound of each pad can be shaped individually. The Result of Insert type compressors is audible in all outputs of the G9 including Direct Outs. Compressors available in **General Settings** affect the sound of the outputted Stereo Signal (Group Track) as a whole. Keep in mind that the effects of both types overlap and that the Output Compressors are applied on top of the pad compressors. At the Output, effects of both types will add up. However, parametrization and functioning are identical.

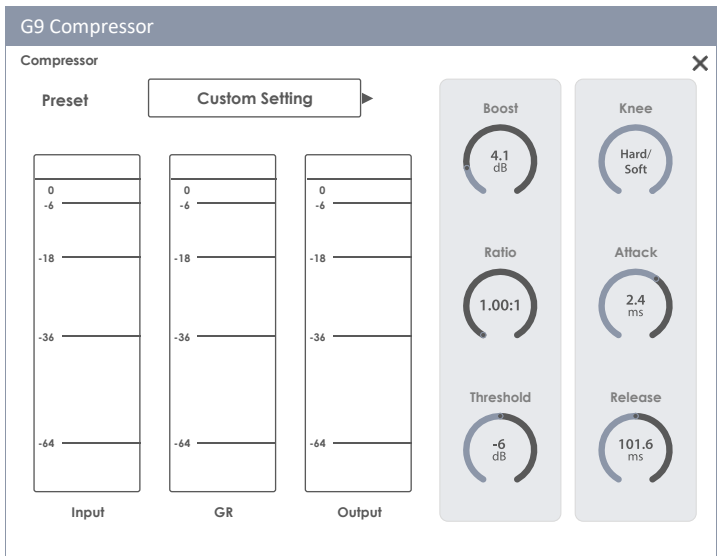

12.2.1.2.1 PARAMETERS AND DESCRIPTION

Compressor - Parameters		
Parameter	Value Range/Unit	Description
Boost	0 - 24 dB	Amplifies the compression result to compensate for the loss in levels caused by the Ratio setting. This parameter applies to the full dB spectrum of the track (threshold settings are ignored).
Ratio	1.00:1 - ∞:1	Sets the amount of compression above the Threshold as a ratio compared to the residual dB level above the Threshold . A Ratio of 1:1 equals no compression. All other parameters won't have any effect.
Threshold	-∞ - 0 dB	Creates a mask or corridor in dB where the compressor is not applied.
Knee	Hard/Soft	Determines whether the compression is faded in (soft) or whether it is applied according to the parameter settings immediately (Hard) as soon as the threshold value is exceeded. "Soft" creates a soft line of transition around the set threshold. Soft "blurs" the Threshold .
Attack	0.09 – 100 ms	Sets a delay time for the compressor to start working, as soon as the level exceeds the Threshold . This way you can keep the attack of the signal and let the compression work only on the tail above a set threshold.
Release	15.5 ms – 6 s	Sets a delay time for the compressor to stop working, as soon as the level drops below the Threshold .

i *Hint: Boost, Ratio and Threshold settings update the input-output curve. Knee, Attack and Release values are not visible in the input-output curve.*

12.2.1.2.2 EDITING COMPRESSOR CURVES

The following steps are a guideline for setting up a compressor:

1. Turn Compressor **[on]**.
2. (Optional) Play a song in **Song Player** and/or play on the drum kit to hear the effect of your edits.
3. Tap the **[Compression]** field which contains the input-output curve. A dialogue pops up giving you access to the compressor parameters.

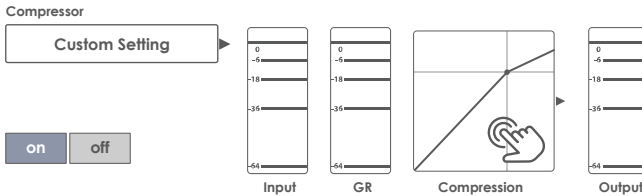

4. Set the **[Threshold]** for the Compressor to start working.
5. Set a **[Ratio]** of gain reduction (**GR**).
6. (Optional) **[Boost]** the signal (Amplify the Signals to compensate for the loss in dB caused by the **Ratio**). Try to match input and output peak meters to bring the signals back to original dB levels without clipping.
7. Set the character of transition (no compression – compression) around the **Threshold** using **[Knee]**.
8. Set a delay for the compressor to start working as soon as the Level exceeds the **Threshold** using **[Attack]**.
9. Set a delay for the compressor to stop working as soon as the Level drops below the **Threshold** using **[Release]**.
10. (Optional) Save changes by storing the drum kit (pad compressors) or save your custom compressor as a preset (pad Compressors and output compressors).



Hint: Pad Compressors are part of the drum kit parameters and can be saved by saving the drum kit or creating a new drum kit (direct storage as "custom setting"). Output compressors in **General Settings** are stored in the device database and are remembered on next start. However, it is recommended to save out a preset to prevent the settings from being overwritten or discarded as soon as you change the drum kit.

12.2.1.3 PRESETS – EQUALIZER AND COMPRESSOR

When you apply this section to **Pad Equalizer** and **Pad Compressors** of the **Kit Editor**, note that aside from storing the preset, the **Drum Kit** may be saved as well to assign the preset permanently. Compressors and Equalizer in mode **General Settings** are no Drum Kit Parameters but are stored **automatically** in the **Device database** (either as a preset or directly). The device database does not require

any separate storage, otherwise there is no difference in the structure of the preset hierarchy. You can simply replace the word "Drum Kit" with "Device Database" in the following illustration:

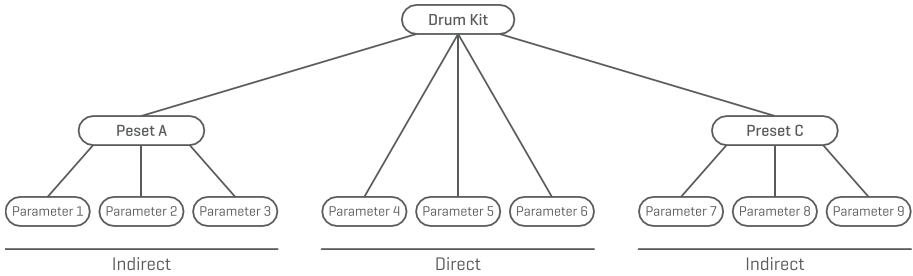

The G9 provides a variety of options to manage preset libraries. You can access the library and its functions by tapping on a [Preset] field next to a group of preset parameters. In the drop-down lists that open up by tapping on a preset field, the G9 differentiates between **Factory Presets** (preceding lock icon) and **User Presets** (without lock icon).

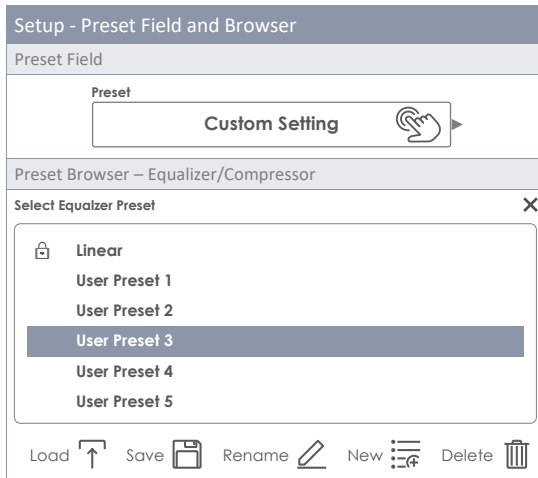

Regarding user presets, the palette of options is extended, since factory presets are not editable. To see the difference between both types, highlight them one after the other by tapping once on the corresponding list entry in the select preset browser.

See the following table for comparison:

Preset Management -Feature Shelf					
Preset Type	Function				
	Load	Save	Rename	New	Delete
🔒 Factory Preset	⬆️			☰☰☰☰☰☰☰☰☰☰	
User Preset	⬆️	💾	✏️	☰☰☰☰☰☰☰☰☰☰	🗑️

12.2.1.3.1 LOADING PRESETS

Proceed as follows:

1. Tap on the **[Preset]** field.
2. Tap once on the preset you want to load.
3. Tap **[Load]** in the Feature Shelf.

The dialog closes automatically, and the new preset is active.

12.2.1.3.2 SAVING NEW PRESETS

In preparation please check whether the **[Preset Field]** contains the name "**Custom Setting**". This indicates that values have changed and differ from those stored with the active drum kit (Pad Equalizer and Pad Compressor) or the values stored in the device database (Output Equalizer and Compressor).

With **Custom Setting** visible proceed as follows:

1. Tap the **[Preset]** field.



2. Tap **[New]** in the Feature Shelf.
3. Name your preset using the keyboard.
4. Confirm by tapping **[OK]**.
5. (Optional for Pad EQ and Compressor) Save the active kit to replace the preset currently stored.

i *Hint: A newly created preset will be added to the preset library only. It is not automatically stored with the active drum kit. **Only for Pad EQ and Compressor (Kit Editor):** To ensure that the new preset loads with the kit, you will have to additionally store the drum kit afterwards. If not, changing the kit will load all presets from the last saving.*

12.2.1.3.3 OVERWRITE PRESETS

You can overwrite user presets with current values set in the interface. This function is not available for factory presets (preceding lock icon).

1. Tap the **[Preset]** field.
2. Tap on the preset name to be overwritten.
3. Tap **[Save]** in the Feature Shelf.

12.2.1.3.4 RENAMING PRESETS

Renaming a preset will affect the preset name only and retain individual parameter values. This option is only available for user presets (without preceding lock icon).

1. Tap the **[Preset]** field.
2. Tap once on a preset name in the drop-down list.

3. Tap **[Rename]** in the Feature Shelf.
4. Enter a new name for the preset using the keyboard.
5. Confirm by tapping **[OK]**.

12.2.1.3.5 DELETING USER PRESETS

This function is not available for factory presets (preceding lock icon).

Proceed as follows:

1. Tap the **[Preset]** field.
2. Tap once on a preset name in the drop-down list.
3. Tap **[Delete]** in the Feature Shelf.

12.2.2 CONTROL

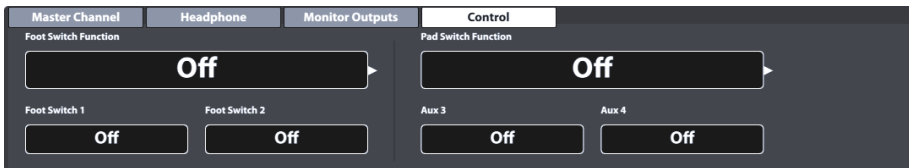

In this function set it is possible assign and manage control settings for peripheral devices choosing options from a predefined list. The G9 allows for choosing between two types of control:

- a. **Foot Switch**
To be chosen in conjunction with standard foot switch pedals sending stereo signals.
- b. **Pad Switch**
For the use in conjunction with standard analog drum trigger pads (stereo).



Hint: Selecting Pad Switch Function will occupy the Aux 3 and Aux 4 input channels. Please make sure that you connect your pads with these inputs in the back of the console.

The options for control functions are the same for both types:

Control Options			
Control	Description	Control 1	Control 2
Off	Disables Control Function	Off	Off
Kit Select	Browse Drumkit Library	Previous Drum Kit	Next Drum Kit
Fixed Hi-Hat	Switch between fixed Hi-Hat and open Hi-Hat	Closed Hi-Hat	Open Hi-Hat
Stage Mode (Open)	Toggles between On Stage and Home Screen	Stage Mode	Home
Song Player	Controls basic Player Functions	Pause	Stop/Play
Setlist Tile Change	Cycle through Stage Tiles	Previous Setlist Tile	Next Setlist Tile
Control Sockets:	(Back of the Console)		
Foot Switch	Foot SW		
Pad Switch	Aux 3, Aux 4		

12.3 MODULE 3

This module hosts the **MIDI (Musical Instrument Digital Interface)** implementation of the G9 to configure the associated ports of the rear panel. Apart from that, MIDI notes sent from each pad can be defined and modified individually for MIDI outputs. These settings are hosted in **Kit Editor** mode. **General Settings** on the other hand handles global MIDI properties (See also section 9.2.2 *Pad MIDI Settings on page 51*).

For users who are new to MIDI:

Note, that MIDI is all about control data and not sound generation itself. All information sent through MIDI connections serve the purpose of controlling other devices by communicating in terms of a common language, so that other devices can interpret information received via **MIDI Input** to trigger certain events on their inside employing internal features and sounds. Thus, sound generation finally takes place in a connected, but remote device. The relationship of MIDI devices inside a MIDI network can be ambivalent: All can function as server and client at the same time.

You can compare the function of MIDI in the digital music world best to the role of sheet music in the traditional way of thinking. Sheet music contains all important information about a piece to reproduce it recognizably, everywhere, with any group of musicians and any instrument (Tempo, key, instruments, arrangement, etc.). The only condition is, that the group of musicians is familiar with reading chart music. Looking at a piece of sheet music does not play notes by itself, it requires instruments and musicians to generate a sound and play the melodies and rhythms transcribed. And as in the digital world, composer, conductor and musician can take all roles at the same time.

In the analogy above the originator is the composer, sheet music the medium and the eye of the musician the receiver. This chain of communication does have its digital counterpart in electronic music: **MIDI**. Since digital devices don't have organic eyes and brains, nor do they possess the limbs to produce the sound, a more adequate way of communication is required, which considers the functioning of a digital piece of hardware and exchanges the same quality of information as written sheet music does. An orchestra of connected, MIDI-speaking devices won't play a single note out of their sound engines if one hands out a written piece of sheet music to them, nor would they know when to change the instrument, even if it is written down on that said piece of paper. This is the task of the **MIDI Protocol**.

12.3.1 MIDI

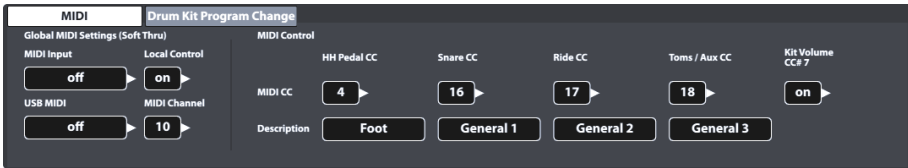



12.3.1.1 GLOBAL MIDI SETTINGS (SOFT THRU)

This function set centers around connecting the G9 with other MIDI devices to form an in-line signal path for MIDI control data to travel through. Utilizing the MIDI 1.0 protocol, it is consequently possible to remote control certain functionalities between the connected devices.

Note that in order to establish a working MIDI Data connection or chain it is crucial to know the MIDI implementation of all devices connected. Please also refer to the MIDI specifications available for the corresponding piece of hardware. This section exclusively focuses on the MIDI implementation of the G9 and how it can live in a chain of connected MIDI devices.





Incoming MIDI Data can be routed to other MIDI devices by utilizing either the analogue **MIDI IN** port or the built in **USB-MIDI** connection. Both ports can be found in the back of the console:

Ports – MIDI	
	MIDI Out - unidirectional
	MIDI In - unidirectional
	USB-MIDI – bidirectional connection (in + out)

12.3.1.1.1 ROUTING MIDI SIGNALS

The first column of the MIDI function set specifies to which output incoming control data is directed. Tap on the corresponding fields for MIDI IN or USB-MIDI and choose the MIDI output to be addressed. Due to the limited number of outputs, no pop-up menu or option wheel will appear. Instead, tap the fields several times to cycle through the underlying list of options. Active values are displayed in the fields visible and will be stored and memorized automatically.

The following table expands the underlying menus for **MIDI Input**, **USB-MIDI**, **Local Control** and **MIDI Channel**. Tapping several times on the corresponding field in the user interface will cycle through the lists in the given order. Highlighted entries (top of the list) mark default factory settings:

G9 MIDI Routing – Fields and Options			
	MIDI Input	Local Control	Selection
	<ul style="list-style-type: none"> • off • to MIDI-Out • to USB-MIDI • to both 	<ul style="list-style-type: none"> • on • off 	
	USB-MIDI	MIDI Channel	Selection
	<ul style="list-style-type: none"> • off • to MIDI-Out 	<ul style="list-style-type: none"> • 10 • 11 • 12 • 13 • 14 • 15 • 16 • off • 1 • 2 • 3 • 4 • 5 • 6 • 7 • 8 • 9 	
Default factory settings are highlighted in bold letters.			

12.3.1.1.2 LOCAL CONTROL

The next column of the **Global MIDI Settings** consists of the fields **Local Control** and **Midi Cannel**. Local Control determines whether G9 MIDI Data can drive the internal sound processor (on) or not (off). Setting Local control to “**off**” is recommended in conjunction with sequencers that route the recorded MIDI information received from the MIDI out of the G9 back into the console to drive the internal sound processor. In this setup the G9 sound processor would receive 2 identical sets of control data if Local Control was set to “**on**”. Turn off Local Control to reduce the amount of received data and avoid unnecessary duplication of signals and unwanted side effects. See the following table for reference:

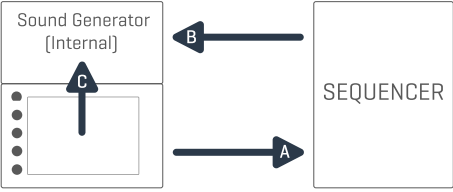
G9 MIDI – Local Control		
Value	Description	MIDI Node Design
on	Control data generated by Input Channels (Pads) drives the internal sound engine (C) and can leave the device via the MIDI Outputs (A). Data looping back into the console indirectly (B) would feed the sound engine with two identical sets of data (B, C), if Local Control was on. Cut MIDI Connection B or turn off Local Control to avoid unwanted side effects.	 <p>The diagram illustrates the MIDI Node Design for Local Control set to 'on'. It shows a 'Sound Generator [Internal]' block on the left and a 'SEQUENCER' block on the right. An arrow labeled 'A' points from the Sound Generator to the SEQUENCER. An arrow labeled 'B' points from the SEQUENCER back to the Sound Generator. An arrow labeled 'C' points from the Sound Generator to a set of four dots below it, representing MIDI outputs.</p>

off	Blocks all G9 MIDI control data received from the Input Channels (Pads) from accessing the internal sound engine. This data can still control other connected equipment via the MIDI Outputs available (A). The control data routs back into the console indirectly via the external MIDI device (B).	
------------	---	--

i *Hint: Check the Local Control setting, if you cannot hear any sound when playing while the trigger monitors receive signals from the connected pads.*

i *Hint: Selecting **MIDI Input to Midi Out** in conjunction with **Local Control "off"** converts the MIDI Out port into a **MIDI Thru** output (Soft Thru). Choose this combination if the G9 is supposed to function as a slave down the line in a "daisy chain".*

12.3.1.1.3 MIDI CHANNEL

Select the MIDI channel on which you want to transmit and receive MIDI Data. There are the 16 channels available. The factory setting is channel 10, which is commonly accepted as standard MIDI channel for percussive instruments.

12.3.1.1.4 MIDI CONTROL

The G9 provides a selected number of hardware components to control other devices or let these instruments be controlled by external MIDI devices. You have the option to assign a limited number of **Continuous Controllers** out of the spectrum of the 127 controllers specified in the MIDI 1.0 standard.

The following table lists all available and relevant **Continuous Controllers** with their controller number and description. The latter is also displayed in the field **Description** below the controlling hardware component. It updates along with the selection of the controller number. As with the **Global Midi Settings**, the selection of controller numbers is realized by tapping the number fields several times to cycle through the underlying menu. Active controller numbers are stored automatically in the device database of the G9. The table below displays an expanded view of the underlying menus. Each controlling component connected to the corresponding **Input Channels** (HH Pedal, Snare, Ride Toms/Aux) has access to the same set of available controllers. In the factory configuration, they are set to different values. You simply start browsing the menu at a different list entry.

List of MIDI messages supported:

G9 Continuous Controllers				
CC Component		Continuous Controller (CC)	Description	Channel Selection
HHPedal CC	- Start (Default) →	• 4	Foot	
		• 11	Expression	
Snare CC	- Start (Default) →	• 16	General 1	
		Ride CC	- Start (Default) →	
Toms/Aux CC	- Start (Default) →			
		• off	off	
		• 1	Modulation	
		• 2	Breath	
Kit Volume	- Start (Default) →	• on		
		• off		

12.3.2 DRUMKIT PROGRAM CHANGE

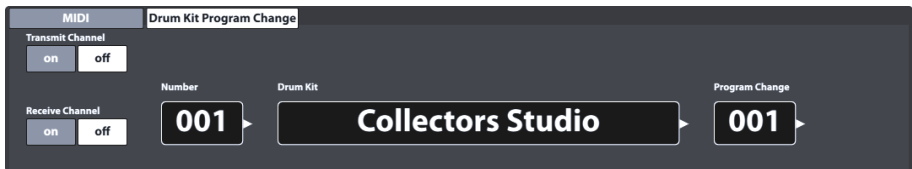

This feature set defines the rules for MIDI program changes. Since the G9 is a rhythm device, it can't be compatible with the standard MIDI protocol. The programs to change are the drum kits available in the **Drum Kit Browser**, where the **Drum Kit index number equals the program**.

Program assignments are displayed as a chain of **Internal Program** → **Internal Program Name (Drum Kit)** → **External Program**. The direction, how this chain is read or applied is defined by the channel switches (Transmit/Receive).





12.3.2.1 PROGRAM PAIRING

To pair an internal Program with an external MIDI Program, proceed as follows:

1. Choose an internal Program (Drum Kit) by doing one of the following:
 - a. Tap the **[Number]** field to enter a Kit Number using the number pad.

- b. Tap the **[Drum Kit]** field to choose a kit from the **Drum Kit Browser** by double tapping.
2. Tap the **[Program Change]** field to enter a program number using the number pad.
3. (Optional) Repeat steps 1-2 for other drum kits.

The settings of the function set apply to the following ports of the rear panel. Make sure that the G9 is connected to the external device in order to let the settings have effect:

Ports – MIDI	
	MIDI Out
	MIDI In
	USB-MIDI (digital)

12.3.2.2 CHANNELS (TRANSMIT/RECEIVE)

The channels available are:

- Transmit Channel
- Receive Channel

Both channels can be turned **[on]** or **[off]** resulting in different applications of the of MIDI program assignment:

Channel States and Effects		
Transmit	Receive	Application
<input type="checkbox"/>	<input type="checkbox"/>	Turns program change off completely (default).
<input checked="" type="checkbox"/>	<input type="checkbox"/>	Only the G9 controls programs of external MIDI devices by changing the drum kit.
<input type="checkbox"/>	<input checked="" type="checkbox"/>	The G9 only reacts to external MIDI program changes by changing the kit according to the linkage of programs in program chain.
<input checked="" type="checkbox"/>	<input checked="" type="checkbox"/>	Change programs of external devices and accept the drum kit to be changed by external MIDI program changes.

Turn **Transmit Channel** on, if you like to change MIDI programs of external devices by changing your drum kit. Turn on **Receive Channel** if you want your drum kits to be changed by external MIDI devices. Turn on both channels, if you want to be able to change other device programs by changing the kit and at the same time accept your kit to be changed depending on a change of external programs.



Hint: Assignments made in this function set will be stored in the device database and are remembered on next start-up.

12.4 MODULE 4

The last module of the General Settings mode hosts all global device adjustments. The features hosted comprise a **shutdown timer**, appearance of the screen and knobs, **UI Themes** as well as important **information about the device**. This module also manages **wireless connections** and allows for performing a **factory resets** and **Updates**.

12.4.1 DEVICE

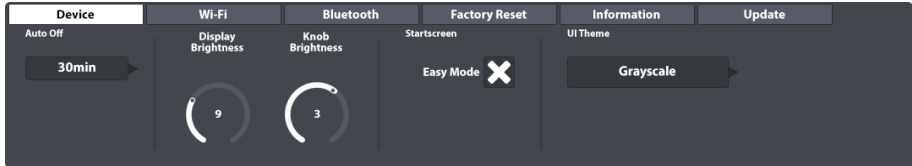

This function set controls all adjustments regarding UI elements. You can adjust **Knob Brightness** and **Display Brightness** independently from each other, as well as programming a timer for shut down. If you feel restricted by the **Easy Mode**, simply uncheck **Start Screen Easy Mode**. From the next restart on the G9 will boot into **Performance Mode**. Parallel to that, the Performance mode will also be set as default screen when pressing the red **Home Button**.



12.4.1.1 AUTO OFF

With **Auto Off** you can time when the G9 shuts down. Tap repeatedly the **[Auto Off]** field to cycle through the countdown times available. There are five options: **off** → **30 mins (default)** → **1h** → **2h** → **4h**.

12.4.1.2 KNOB BRIGHTNESS

To adjust the **Knob Brightness**, proceed as follows:

1. Tap once on the corresponding visual dial to activate the fader.
2. Drag your finger up and down until you find a brightness you are happy with.
3. Close the fader by tapping on the dial icon again.

 **Hint:** Brightness adjustments are stored real-time, meaning that the last brightness value set will be kept and saved in the global device database, even if you leave the mode.

12.4.1.3 START SCREEN

By unchecking “**Start screen Easy Mode**” the G9 will be act as follows:

- a. The device boots in **Performance Mode** on next start up.
- b. Performance Mode is set as default screen when pressing the red home button.

12.4.1.4 UI THEME

The appearance of the G9 is customizable by different UI Themes. Tap on the field and select a theme using the selection wheel.

There are also themes dedicated to different types of color blindness. These themes are named after medical terms and utilize only color values from the perceivable spectrum of the concerned group of people.

Themes dedicated to color blindness are:

- Deuteranopia
- Protanopia
- Tritanopia
- Grayscale



Hint: Themes dedicated to color blindness change colors in important monitors of the UI as well. The interpretation of these monitors depends on the colors visible. Color values and their meanings are explained in the relevant sections of this manual. To this end it is recommended reading this manual on a screen or printing it in color.

12.4.2 WI-FI



Within this function set you can manage all your Wi-Fi connections and settings. The Wi-Fi connection is essential to the use of the sound store online as well as the internal update function.

To establish a Wi-Fi connection between the built-in card and the external router, proceed as follows:

1. Turn on Wi-Fi.
2. Tap the **[Search]** button.
3. Select a Network from the List that opens up tapping once.
4. Tap **[Select]** once.
5. (Optional) Tap the field **[Network Key]**, if the network requires a password.
6. (Optional) Enter the Wi-Fi password using the keyboard.
7. (Optional) Confirm by tapping the **Hook [✓]** to close the keyboard.
8. Tap **[connect]**.

Consequently, the network will update to the network selected in step 3. If your connection has been established successfully, all connection information such as IP-Address and Subnet mask will appear on the right-hand side. If no information appears, please repeat steps above with **show key** set to "on" (step 5) and make sure that you have entered the Wi-Fi password correctly.

12.4.3 BLUETOOTH

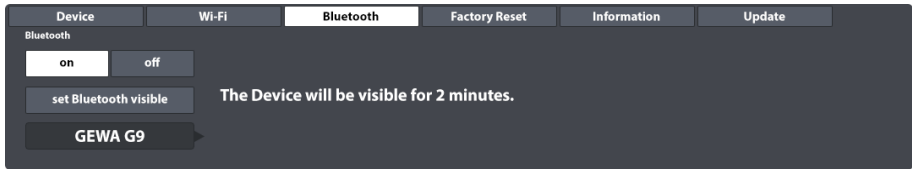

The built in Bluetooth function is useful for streaming music from an external player into the console. To establish a Bluetooth connection, you need to follow the steps below. Note that steps 2-5 take place on your mobile device and the procedure might vary from manufacturer to manufacturer. Please refer to the owner's manual of your mobile device if you have problems establishing a working Bluetooth connection:

1. In the GEWA G9 go to **General Settings → Module 4 → Bluetooth**
2. Make sure that Bluetooth is turned **[on]** and tap **[set Bluetooth visible]**.
3. Turn on Bluetooth in your external device and open the list of available network connections.
4. Scan to refresh the list.
5. Select the console from the list of available devices (e.g. GEWA G9).
6. Enter the Bluetooth password (factory default: **4392**).



The password is fixed and unified for all GEWA drum consoles and digital pianos. Enter **4392** (as if you were writing GEWA on a number pad).

i *Hint: Be aware of the **interaction between Bluetooth and the MIX IN port**. Bluetooth signals and signals from the MIX IN port cannot be played back at the same time. As soon as Bluetooth is turned on, audio signals from connected devices at the MIX IN port will be muted. The G9 routes the signals with priority for the last action. Consequently, plugging in an audio cable at the MIX IN port while playing back audio via Bluetooth will mute Bluetooth audio and prioritize MIX IN. Disabling one of these input types by either unplugging MIX IN cables or turning off Bluetooth will cause the device to automatically switch to the other input type.*

12.4.3.1 CUSTOM BLUETOOTH NAMES

If your G9 is in the close neighborhood of other G9 devices, you can change the Bluetooth name of your G9 to make it uniquely recognizable for other external devices and facilitate the pairing process. Bluetooth names are stored in the global device database automatically and are remembered until changing the name again or until performing a **Factory Reset**.

Proceed as follows:

1. Go to **General Settings → Module 4 → Bluetooth**
2. Tap the **[Bluetooth Name field]** below **[set Bluetooth visible]**.



3. In the dialog that opens you have two options:

- a. Tap **[set Name]** to close the dialogue and set the name shown in the display.
- b. Tap the field containing the current **[Bluetooth Name]** and enter a custom name using the **Keyboard**.

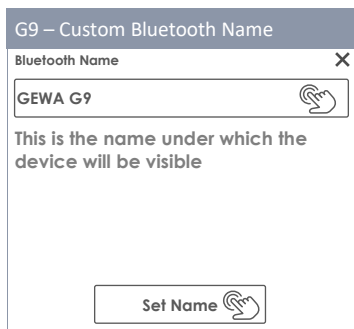

4. Confirm by tapping the Hook [✓] in the Keyboard.

12.4.4 FACTORY RESET

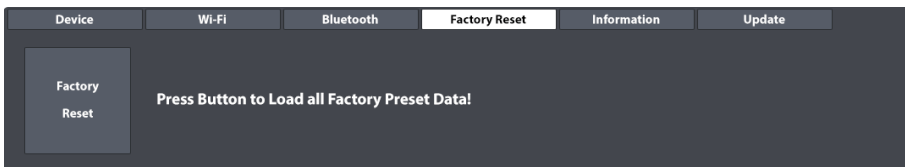

A factory reset will restore the default settings of the firmware version installed. The routine deletes custom drum kits, presets and device parameters altered since the last firmware update. However, it is possible to create a backup of drum kits using the export function of the **Drum Kit Browser**. The export routine will save all drum kits in the default system folder on the internal SD card, which is excluded from the factory reset. This way you can import your drum kits easily after the factory reset. Sounds purchased in the **Shop** must be downloaded and reimported again. A firmware upgrade on the other hand will retain all settings and drum kits. Please save your custom drum kits before you proceed.

To perform a factory reset of the G9, proceed as follows:

1. Go to **General Settings** → **Module 4** → **Factory Reset**
2. Tap the **[Factory Reset]** button.
3. Wait for the reset to be completed.
4. Confirm by tapping the **hook [✓]** in the success message dialogue.

12.4.5 INFORMATION

Device	Wi-Fi	Bluetooth	Factory Reset	Information	Update
Serial Number: TS2002197 Firmware: V 1.18 Dream FW: V 1.30 Trigger FW: V 20200711 SoundBank: V 1.05 TriggerBank: V 20200723				SD Memory used / total: 5,98 GB / 115.21 GB Sample Flash used / total: 2,00 GB / 4,00 GB	

This function set provides all information regarding the status of the G9 such as **Serial Number**, **Firmware** version, sound chip firmware version (**Dream FW**) and version number of the trigger firmware (**Trigger FW**). Also shown is the status of the internal memory usage (**Flash** for imported sample Libraries and **SD Memory**).

Please always communicate Serial Number, Firmware Versions and installed Sound Bank/Trigger Bank versions when contacting the customer service. This information speeds up the process of solving issues.

12.4.6 UPDATE

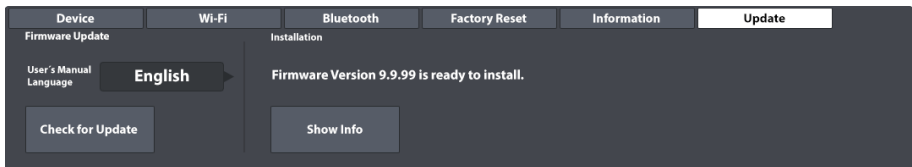

The G9 provides two different ways of downloading firmware and manuals as well as two options of updating your device. The update process is split into 2 steps: Download and Update. You can choose between downloads from the support center on gewamusic.com or downloads directly to your G9 using the download function of the update tab. The update routine itself can be executed from either USB Stick or the internal **Update** feature of the workstation. Which way you choose is up to you. However, with a working Wi-Fi connection available, it is recommended to completely use the workstation for downloads and update.

12.4.6.1 DOWNLOAD - FIRMWARE AND MANUALS

Both, website and workstation derive their files from the same source. Thus, it is up to you, which way you choose.

12.4.6.1.1 DOWNLOADS FROM GEWAMUSIC.COM

1. Go to gewamusic.com → Service → Downloads
2. or follow this link:

<https://int.gewamusic.com/downloads>

3. Choose "Drums" from the option wheel.
4. Download your files following the instructions.



12.4.6.1.2 DIRECT DOWNLOAD VIA MODULE



The direct download feature avoids media disruptions, resulting in a fast and easy procedure to keep your G9 up to date.

Please follow the steps described below:

1. Make sure you have established a working Wi-Fi connection.
2. Go to **General Settings** → **Module 4** → **Update**
3. Tap on the **[Language field]** to choose the language of the manuals provided.
4. Tap **[Check for Update]** to open the **Update Dialogue**.

The G9 compiles all relevant downloads in the language of choice and by checking the installed firmware, it only provides software newer than the installed version. To restore the installed firmware, please perform a factory reset.

Observe the **Change Log** field for important information of what the user can expect from the selected update and manual. Using this method, the latest **Firmware** and the latest **Manual** will be downloaded at the same time.

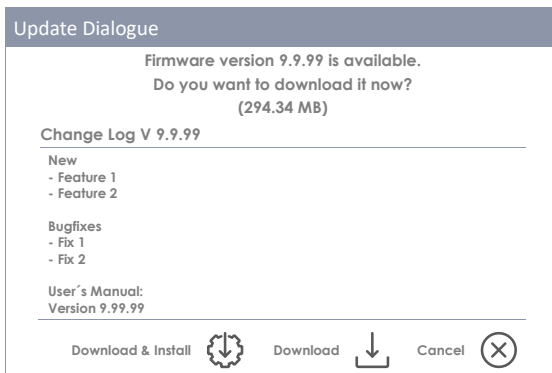

5. Choose one of the following options from the bottom of the dialogue:
 - a. Tap **[Download & Install]** to install the firmware automatically after the download.
 - b. Tap **[Download]** to download the files only.
 - c. Tap **[Cancel]** to abort and close the dialogue.
6. In case of 5a, wait for the update routine to be completed and confirm by tapping **[Re-boot]**.

If you would like a copy of the owner's manual on a USB Stick, or if you prefer to use the update option via USB, you can find your downloads in the default system folders on the internal SD Card. Use the **File Manager** to get access to your downloads. (Go to **Tools** → **File Manager**)

The relevant folder paths are:

- Firmware: **INTERNAL SD/SYSTEM/Firmware**
- Manuals: **INTERNAL SD/SYSTEM/Manuals**

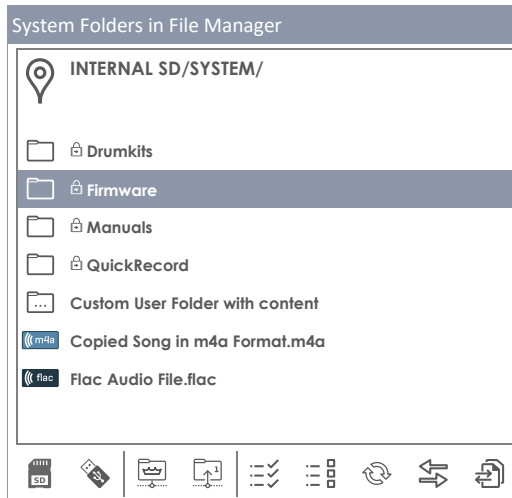

12.4.6.2 UPDATE YOUR DEVICE

i Important: Note that the update routine requires a specific file naming convention and file extension in order to work correctly. Please **do not rename firmware files** or change their file extension (*.swu).

12.4.6.2.1 SOFTWARE UPDATE VIA USB

Proceed as follows:

1. Extract the downloaded files.
2. Copy the firmware (edrum_fw_*.swu) to the **ROOT directory** of your USB stick.
3. Turn off your G9 by pressing the **[Power]** button.
4. Plug the USB stick into the USB port of the front panel.
5. Turn the G9 on by pressing the **[Power]** button again and wait for the update to be completed (pop up with status message).
6. Remove the USB stick from the USB port.
7. Tap the **[Reboot]** button in the status message.

G9 - Update via USB

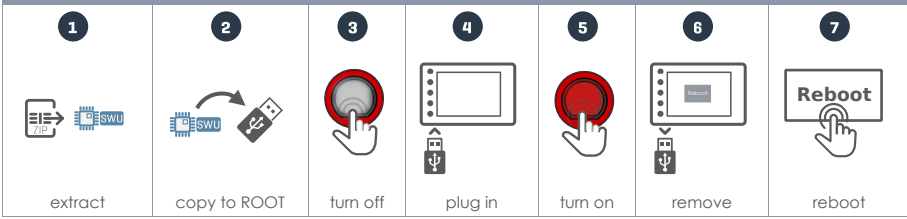

i **Tip:** Check the successful update in the information tab. Go to **General Settings → Module 4 → Information**. The Firmware version should have updated accordingly. If you observe trigger version V0, another reboot might be necessary.

i **Tip:** In combination with the direct firmware download you can grab the unzipped firmware from the default download folder and copy it on your USB Stick using the G9 File Manager. The default download path for firmware files is **INTERNAL SD/SYSTEM/Firmware**.

i **Tip:** Reserve a USB stick for updates only. With plugged in USB stick and firmware update files in the root folder, the G9 enters the update routine automatically even if the firmware version is already installed. Save time by using USB dongles with different purposes or, alternatively, remove any *.swu file from the root directory right after the update.

12.4.6.2.2 UPDATE ROUTINE VIA MODULE

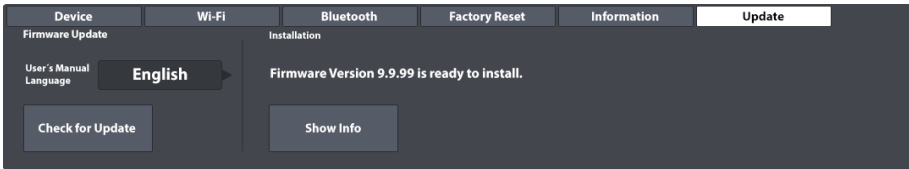

The Update section of the G9 derives its data from the default SYSTEM folder "Firmware" on the internal SD Card. All files contained meeting the criteria for check sums, naming conventions and version number will be considered. The latest valid firmware version will be provided for Installation. In that sense the update section operates as a firewall for defective and modified files.





To install previously downloaded firmware, proceed as follows:

1. Go to **General Settings → Module 4 → Update**
2. Downloaded Firmware Upgrades will result in a notification in the Update Tab. Only the latest version will be provided for Installation.
3. Under the section **Installation** tap **[Show Info]**.
4. In the Update dialogue, tap the button **[Install]** below the change log.
5. Wait for the autonomous update routine to be completed (success message).
6. Confirm by tapping **[Reboot]**.

13 TOOLS



The tools mode contains app-like utilities and features like an **On Stage** mode, **PDF Reader**, an **Import Tool** for sound samples and a **File Manager**. Tapping an icon in the Tools menu will open the associated application. See the following table for icons associated with the tools available:

Tools Menu	
	On Stage – compile media for setlists including charts in pdf format
	PDF Reader – supports bookmarks
	Import Tool - add samples to the sound library
	File Manager – organize files and folders
	Shop – lists your purchased multi-layer sounds

13.1 ON STAGE



With the **On Stage** tool it is possible to compile important information around a song such as drum kit (sound), metronome, backing tracks and pdf charts, and make altogether available by tapping on one of the numbered tiles. This way you can avoid time consuming adjustments on stage and between the songs.

The **On Stage** screen always displays 8 tiles which can be saved as preset setlists and which can be loaded one after the other as the gig progresses. A setlist always consists of 8 tiles, representing 8 songs.

To open the On Stage tool, tap the **[Tools]** mode icon and tap **[On Stage]**.



On Stage



PDF Reader



Import Tool



Shop



File Manager



Tools

This opens the default On Stage screen:

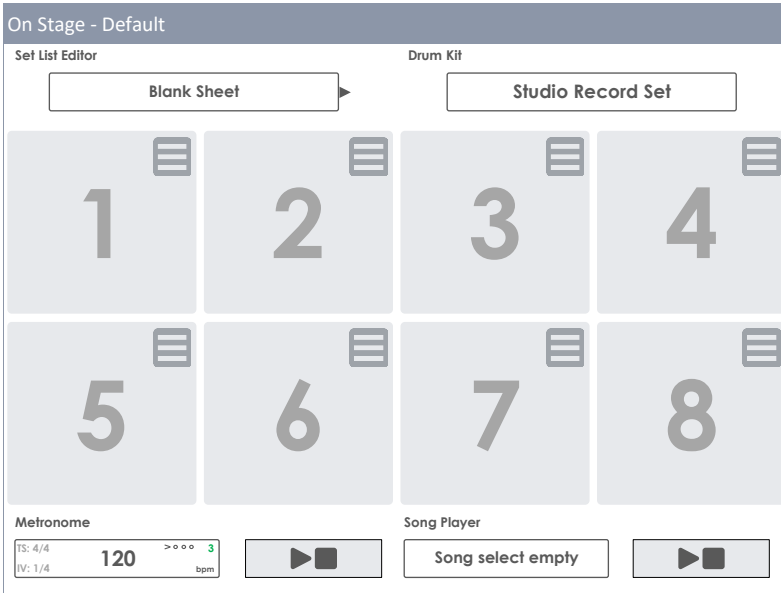

The following sections will focus on editing tiles, managing setlists and working with setlists on stage.

13.1.1 TILES – ASSIGNABLE MEDIA TYPES

While editing a tile you can specify settings and files for the following 4 types of media, which will be loaded when tapping on the tile number outside the edit mode:

- Drum Kit Name
- Metronome Tempo
- Backing Track (Song Player)
- Pdf files (Lead sheets or Charts)

The fields on screen associated with these media types will display the current tile expressions specified for each type. In edit mode you can tap these fields to change the properties of the tile.

This will open the standard dialogues associated with a media type. In this section we won't go into depth about these browsers again. See the following table for the dialogues implemented and the chapter where their functioning is explained in more detail:

Tiles - Media Types and Associated Dialogues		
Field Name	Dialog	Section - Title
Drum Kit	Drum Kit Browser	8.1.1.1 Managing Drum Kits (Presets)
Metronome	Number Pad	8.4.1 Metronome
Song Player	File Select (Audio Filter)	8.3.1.1 File Select Browser
PDF	File Select (PDF Filter)	13.2.1 File Select Browser

13.1.2 EDITING TILES – ASSIGN EXPRESSIONS FOR MEDIA TYPES

In preparation, please tap the **[Setlist Editor]** field and load the preset **Blank Sheet** by double tapping on the preset name. This will load an empty setlist with default values. The proceeding described in the following applies to creating new presets using the blank sheet preset as well as editing tiles of any other existing setlist.

Tile Edit – Icons and their Meaning	
	Edit Tile
	Attach PDF File (Tap) – Remove File (Hold down 2 seconds)

With an adequate setlist loaded, proceed as follows:

1. Tap on the **[Edit]** button in the top-right corner of a tile.
2. Tap the fields that have changed color.
 - a. Drum Kit
 - b. Metronome
 - c. Song Player
 - d. Attach Pdf button
3. Specify the expression of media types in the browsers that open.
4. Exit the tile edit mode by tapping the **[Edit]** button again.
5. Tap the next tile number and repeat steps 1-4.
6. When having edited maximally all 8 tiles on screen, save the tile set as a **Setlist** (see the next section on set lists).

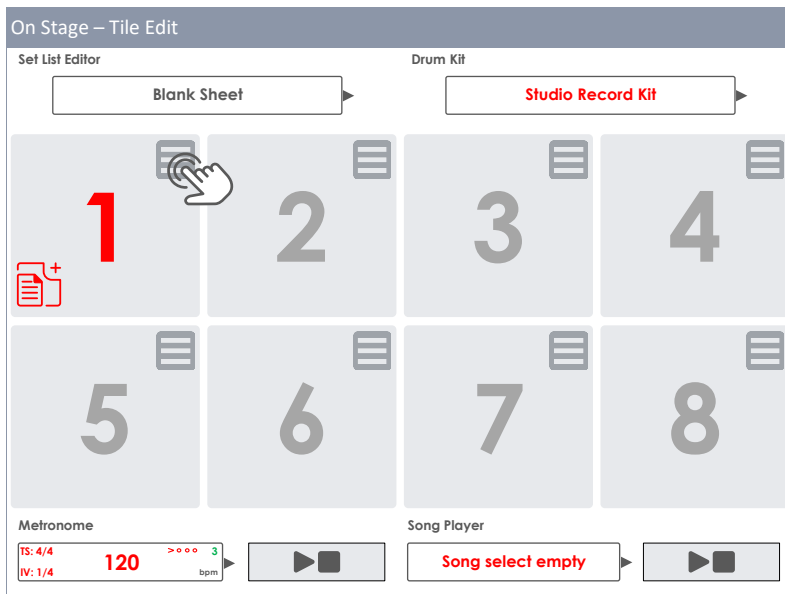

13.1.3 SETLIST PRESETS

A set of 8 occupied tiles can be saved as a setlist, which remembers all media types assigned to the different files once the setlist is loaded. The UI will update as soon as a tile of the loaded setlist is activated. A setlist is the same as a preset and is treated the same way. Regarding setlists, the preset browser provides only one preset called "Blank Sheet". This preset loads default values without any pdf attachment. If you are already familiar with preset management in other modes such as **Kit Editor** or **Effects**, you can skip this section.

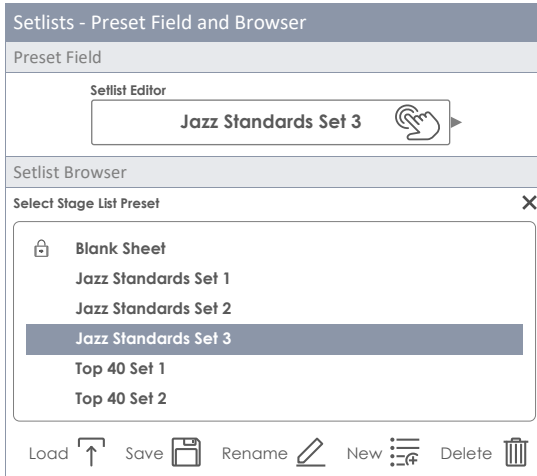

As with all other G9 presets, the feature shelf updates depending on the chosen preset type (Factory or User):

Preset Management -Feature Shelf					
Preset Type	Function				
	Load	Save	Rename	New	Delete
Factory Preset					
User Preset					

13.1.3.1 LOADING SETLISTS

To load a Setlist proceed as follows:

1. Tap the **[Setlist Editor]** field to open the Setlist Browser.



2. To Load a Setlist do one of the following:
 - a. Via Feature Shelf

- i. Highlight a list entry (Tap once).
 - ii. Tap **[Load]** in the Feature Shelf.
- b. Double tap a list entry.

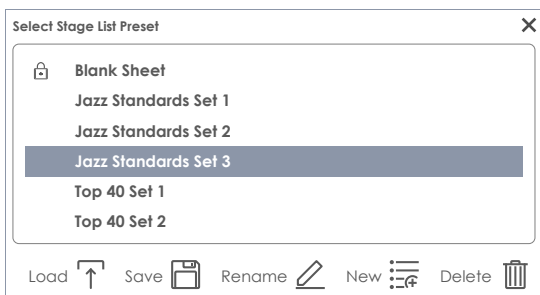

13.1.3.2 NEW SETLISTS

Proceed as follows:

1. Load a preset to start from.
2. Edit the files as desired (The **Setlist Editor** field updates to "Custom Setup").



3. Tap the **[Setlist Editor]** field to open the setlist browser.
4. Tap **[New]** in the Feature Shelf.
5. Name the new setlist using the keyboard.
6. Tap **[OK]** to confirm.

i *Hint: It is possible to create a new setlist before editing the files: Load a preset to start from, open the preset browser again and tap **[New]**. After that you can edit the files and overwrite the preset with **[Save]**.*

13.1.3.3 SAVE SETLISTS

Save allows for saving edits of a setlist as well as overwriting presets in the setlist browser with the values of the current file set. This option is only available for user setlists.

Proceed as follows:

1. Load a preset to start with.
2. Edit the tiles as desired (The **Setlist Editor** field changes to "Custom Setup").



3. Tap the **[Setlist Editor]** field to open the setlist browser.
4. In the preset browser highlight a user setlist to be overwritten (tap once).
5. Tap **[Save]** in Feature Shelf.

This overwrites the chosen preset with the current tile layout.

13.1.3.4 RENAME SETLISTS

Renaming of setlists is always possible without overwriting their tile configuration. This option is only available for user setlists.

Proceed as follows:

1. Tap the [**Setlist Editor**] field to open the setlist browser.
2. In the preset browser highlight a user setlist to be renamed (tap once).
3. Tap [**Rename**] in the Feature Shelf.
4. Enter a new name using the keyboard.
5. Confirm by tapping [**OK**].

13.1.3.5 DELETE SETLISTS

This option is only available for user setlists.





Proceed as follows:

1. Tap the [**Setlist Editor**] field to open the setlist browser.
2. In the preset browser highlight a user setlist to be deleted (tap once).
3. Tap [**Delete**] in the Feature Shelf.
4. Confirm by tapping [**OK**].

13.1.4 WORKING WITH SETLISTS

Setlists can be used in different ways. Their main purpose is to make available important settings associated with a song by tapping a single button (tile number). But also, during your practice routines it can contribute to a more efficient time management by providing matching charts, drum kits, tempo and audio files. Tapping a tile number is very convenient instead of selecting all media individually in **Performance** mode and **Pdf Reader** every time you sit down to practice the same song.

Tapping a tile number gives access to all media assigned to a tile. See the following table for icons and buttons that can appear within a tile:





Loaded Setlists– Icons and their Meaning	
	Edit Tile
	Attached File
	Open File in Pdf Viewer
	Play/Stop (Song and Metronome)

If set lists are longer than 8 songs, it is possible to spread the songs over several **On Stage Setlists** and load these lists one after the other.

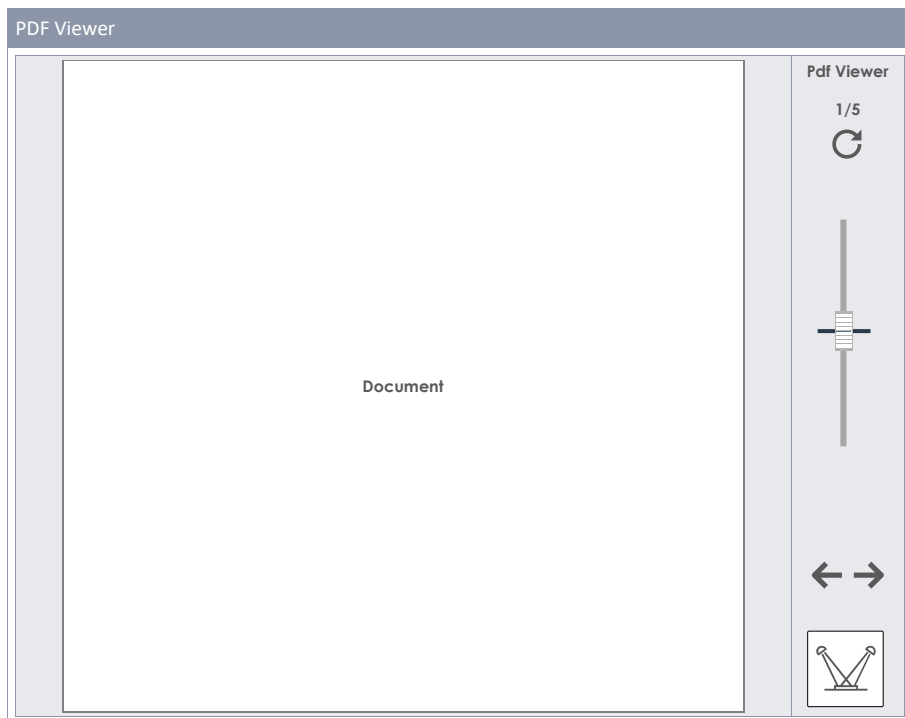
13.1.4.1 PDF VIEWER

The On Stage Pdf Viewer is a simplified version of the Pdf Reader (*see on page 142*). It provides only the most important functions for reading chart music. During live performances you need to turn pages quickly and have fast access to the **[Play/Stop]** buttons of the On Stage mode to quickly react to issues on stage. The built-in **[Exit]** button closes the Pdf viewer and returns to the active file in **On Stage** mode. The allocation of these functions at the bottom minimizes the distance to the player and thus speeds up the workflow.



Pdf Viewer	
	Exit to On Stage Screen (Closes Pdf Viewer)
	Next page
	Previous page
	Zoom
	Turn page clockwise

13.2 PDF READER



The PDF reader allows you to read any PDF stored onto a USB stick or the internal memory, which is especially useful for reading sheet music. Next to basic navigation functions, it also provides advanced functions such as **bookmark navigation** and **thumbnail navigation**.



On Stage



PDF Reader



Import Tool



Shop



File Manager



Tools

Tapping on **Tools** → **Pdf Reader** will open the application. All functions available are visible in the start screen:

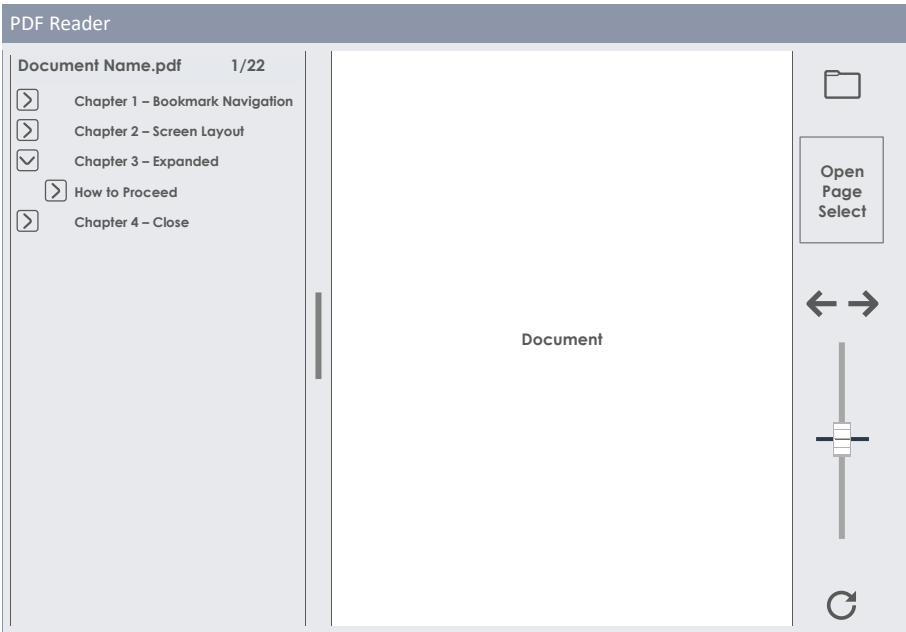

The following table explains buttons and icons of the start screen:

PDF Reader - Functions	
	Open File Select Browser
	Next page
	Previous page
	Zoom
	Rotate page clockwise in Increments of 90°
	Expand bookmark hierarchy
	Collapse bookmark hierarchy

13.2.1 FILE SELECT BROWSER

The File Select Browser is implemented in various applications in the G9, such as the **Song Player**, **PDF Reader** or **Import Tool**. However, depending on the application, it opens with different filters active to only show relevant file types. Regarding the **PDF Reader**, it displays pdf files only. Consequently, non-interpretable files are hidden.

13.2.1.1 PROPERTIES

The top-left side hosts buttons for **selecting storage mediums**, as well as the **search function**, which can be utilized as an alternative to linear path navigation. All these buttons are activated by a **single tap**.

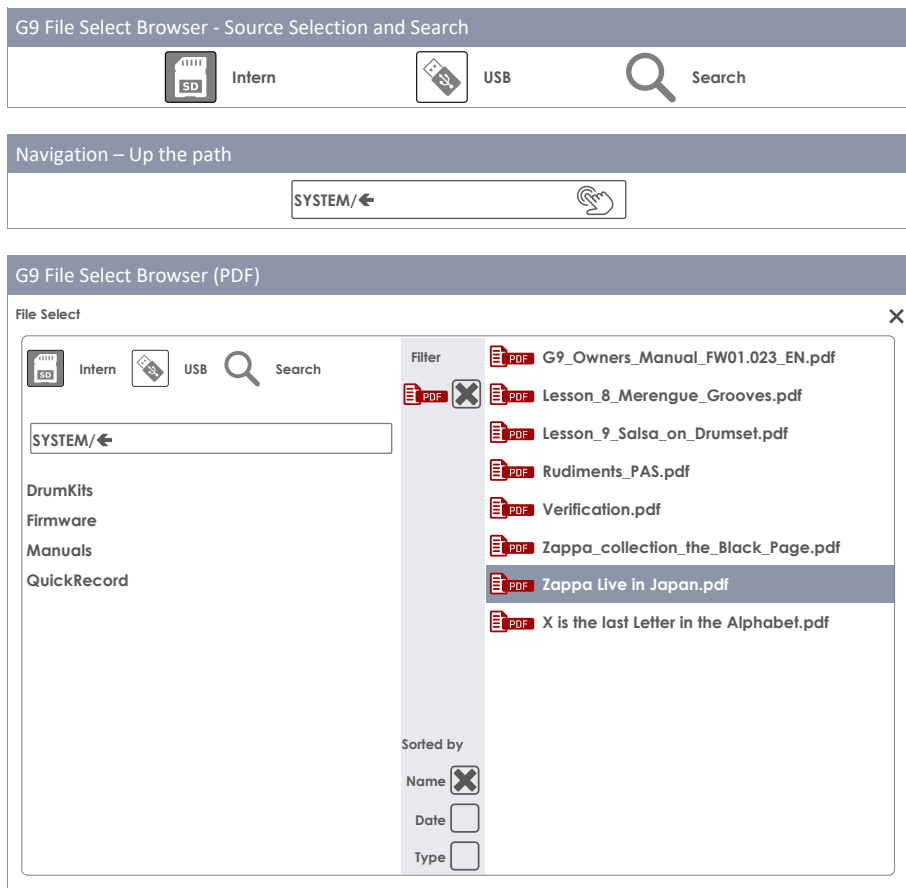

The **left column** displays all **folders** in the open directory, the **right column** lists all contained **files**. Double tap on a folder name to open it moving down the directory path. Tap on the **[white bar]** below the **[SD]** and **[USB]** buttons to move up the path by one node each tap. The **panel in the middle** contains **filter** options and **sorting functions**. Check the boxes as desired to display contents the way you prefer.

13.2.1.2 OPEN PDF FILES

In **Pdf Reader**, proceed as follows:

1. Tap on the [Folder] icon in the top-right corner to open File Select.



2. Specify the storage medium by tapping once on **[USB]** or **[SD]**.



3. Navigate to your file by performing one or more of the following actions.
 - a. Double tap on folder names to open them (left column).
 - b. Move up the path by tapping the **[white bar]** (left column).



4. Select a file to open by double tapping list entries in the right column.

13.2.2 BOOKMARKS AND THUMBNAILS

Extensive documents with many pages like this manual are hard to navigate through without any anchor points to relate to. But we wanted to prepare the information of this manual in a way that it is easily accessible inside the console, so that users can quickly jump to those sections where they need help.

If a document contains bookmarks, then they are displayed in the left half of the resizable window next to the open page. Bookmark hierarchies can be opened and collapsed by tapping on the preceding arrow buttons.



Tap in the center of the dividing bar between both split windows and **resize the bookmark bar** as desired by dragging. Tapping on a bookmark name, will directly jump to the top of the page, where the section starts. Possibly, you must scroll down if the title is at the bottom of the page.

Inside the navigation bar on the right-hand side you can see a **[thumbnail]** of the open page. Tap on the thumbnail to open the **Page Select** browser. Tapping once on a thumbnail in Page Select will open the selected page directly without working your way through the bookmark hierarchy. Page select is the quicker method for opening certain pages directly, if the page contains clearly distinguishable images or drawings.

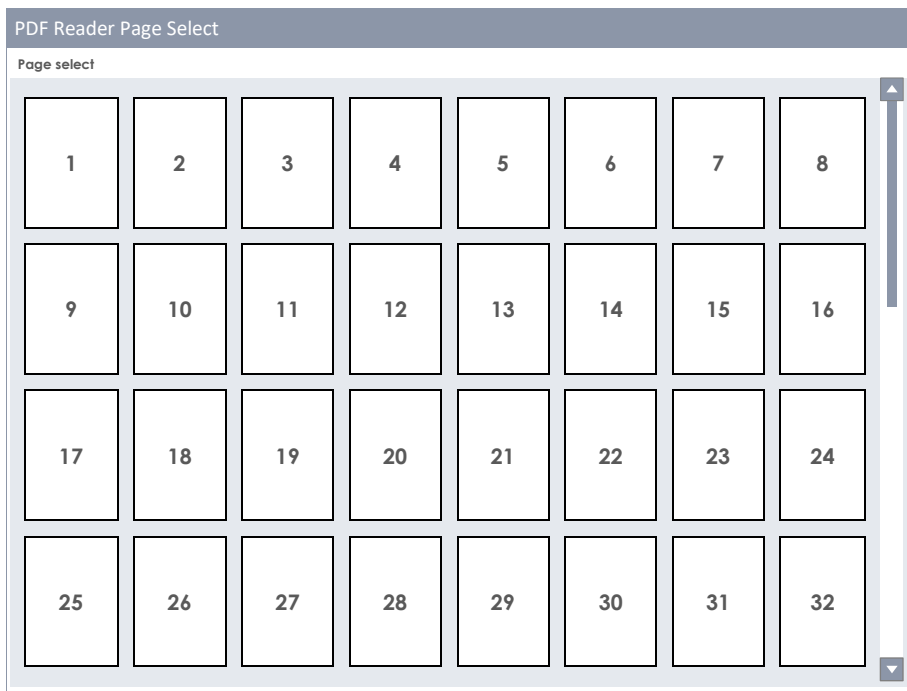

13.3 FILE MANAGER



The built-in file manager is an application to transfer data between an external USB device and the internal SD card. It can be used to manage your files as you would do on a regular PC or Mac. Move, copy, delete and rename files and folders of both sources (internal SD card and external USB device). There is no limit for file extensions, but keep in mind that the G9 may not provide applications to open them. However, it is possible to comfortably manage all storage mediums and file types without any external operating system. Icons are provided for the most common file extensions to easily distinguish between them when browsing folders.

The ability to store your own files in the G9 makes a USB dongle obsolete. You can access your files wherever you go without carrying any other storage medium.



On Stage



PDF Reader



Import Tool



Shop



File Manager



Tools

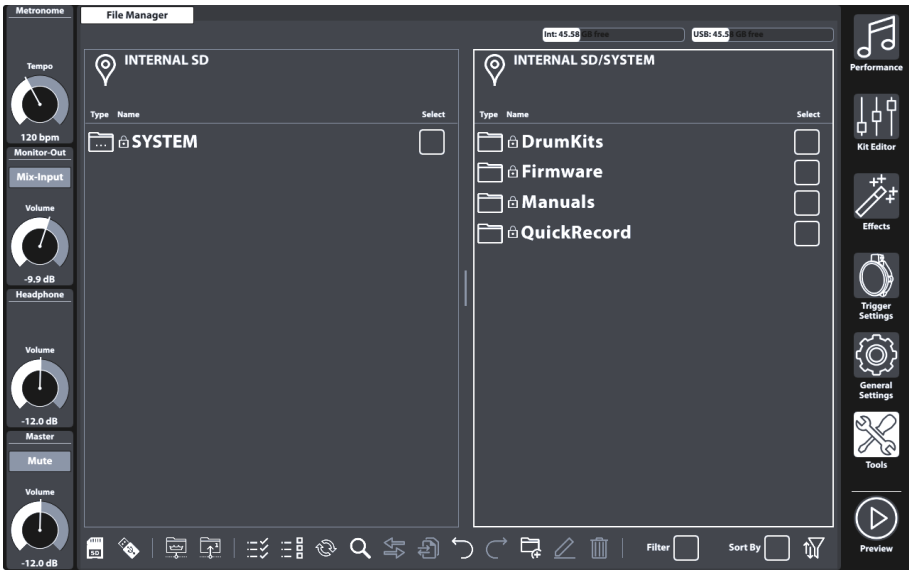

13.3.1 FILE MANAGER VS. IMPORT TOOL

The **Import Tool** is designed to add samples to the **Sound Library** of the G9. It does not transfer data onto the internal SD card, but takes sound files from any source and encrypts the sample file into the G9's native library format. Samples are encrypted and filed under the matching instrument category in the library. Consequently, samples are finally stored on the built-in **Flash Memory** for fast access and minimal load time. Files transferred via the **File Manager** are stored on the internal **SD Card**. In conclusion, **Import Tool** and **File Manager** address different storage mediums and applications.

13.3.2 SCREEN LAYOUT AND GENERAL PROPERTIES

The File Manager is in the **Tools** mode (**Tools** → **File Manager**). Once you open it, a split window becomes visible. The top section informs about the current memory usage of all accessible storage mediums. Two horizontally resizable split windows allow for opening two different folders from either USB or internal SD Card. The header of each split window displays the path of the opened directory. Check boxes allow for selecting list entries and the task bar at the bottom provides tool for navigation, selection and filtering of folder contents.

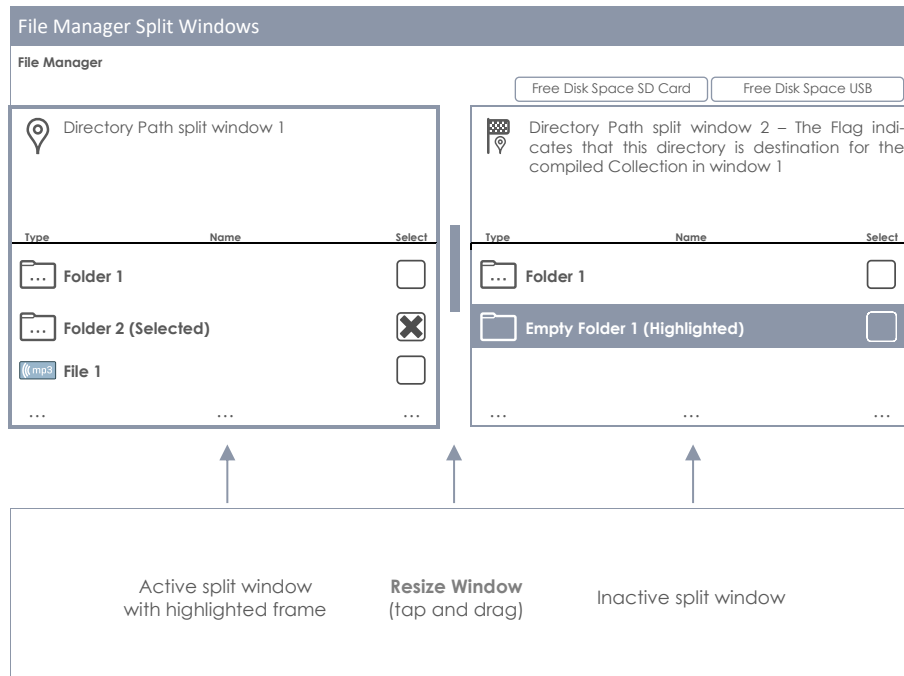

13.3.3 TASK BAR



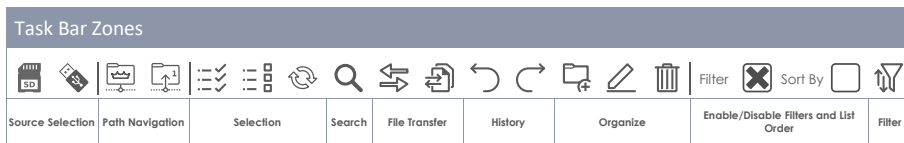













The task bar hosts all tools to organize your files. Apart from filters and sorting properties, which apply to both split windows, all functions (buttons) will take effect in the active split window above. The active split window is characterized by a highlighted frame. To change the active window, simply tap inside its frame and let the task bar functions affect the split window of your choice.



- with icons for navigation and actions
 - Selection of drives
 - Navigation via icons for path nodes (Root Directory, Folder level Up)
 - Search function (active directory and below)
 - Filter Manager for filters and ordering.
 - Selection functions for transfer of collections (Transfer Job)
 - Differentiation between highlighting and selecting
 - Undo and Redo function (tracking the last 10 steps)

- Create new folders: always possible in the active split window, regardless whether there are existing collections
- Rename Files/Folders (only one list entry at the same time)
- Delete Files (batch processing)
- Transfer buttons (Move/Copy) to start the transfer Job.

The following table explains the icons of the Task Bar:

Task Bar	
	Internal SD card (opens root directory)
	External USB device (opens root directory)
	Go to root directory of the active path in active split window
	Move up one level in the folder hierarchy
	Check All
	Uncheck All
	Refresh (empties the collection of the active split window)
	Search
	Transfer: Move selected to defined destination
	Transfer: Copy selected to defined destination
	Undo (up to 10 steps)
	Redo (up to 10 steps)
	New folder (preserving existing collections)
	Rename highlighted list entry (preserving existing collections)
	Delete selected
	Opens the Filter Manager

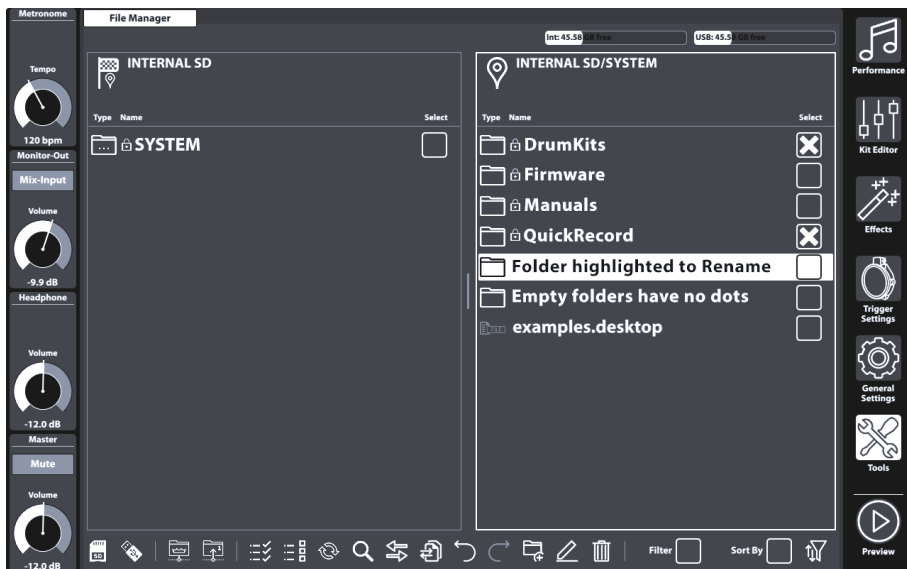

13.3.4 COLLECTIONS – CONCEPT AND OVERVIEW

Compiling a collection is the process of gathering several files and folders from multiple path directories of multiple sources (SD, USB) **within the same split window**. During this process, the G9 remembers the path directories of all selected items in the background, allowing to navigate seamlessly between sources and their folder hierarchies and without losing track of the files and folders selected. The built-in search function can be utilized at any time as an alternative to the linear navigation methods. A collection is opened when selecting the first list entry in a split window by tapping one of the **check boxes** in the **Select** column.



The definition of a **collection** extends the understanding of file management in ordinary file browsers and distinguishes itself from the term **selection**. While traditional file managers discard file selections as soon as you leave a folder to open a different directory, the G9 file manager remembers these selections, allowing to add more files from other directories. Thus, **a collection consists of selections spread out on different directories and storage mediums. In other Words: with collections you can treat different storage mediums as if they were different folders of the same drive.** Collections and selections are identical as long as you stay inside the same directory while selecting files. This means also, that you can approach the G9 file manager as any ordinary file manager without noticing any difference. The benefit of collections comes into play, when selecting many files from many directories: As opposed to the traditional way of copying files step by step before leaving a folder, the collection feature saves all intermediate steps and requires executing **job tasks** only once. Since the G9 file manager provides two split windows, the user can compile **maximally two parallel collections for maximally 2 different destination folders.**

Finally, when having compiled your collections you can apply a collection-based **job task** which will affect the collection of the active split window. The following collection-based job tasks are available:

Collection Based Tasks (Batch Processing)	
	Move
	Copy
	Delete

Tapping a task button will execute the chosen task for the **active split window**, preserving existing collections of the opposite split window. Other existing collections of the opposite window can be executed afterwards, allowing to choose a different job task if desired. There is no undo or redo possible once a job task button is tapped. However, in case of **Delete**, a warning message will appear and ask for confirmation to proceed, giving you the possibility to change your mind and

cancel the operation. Tapping the **[Refresh]** button will delete the collection of the active split window.

13.3.5 COMPILING COLLECTIONS

Proceed as follows:

1. Tap inside a split window to activate it as starting point.
2. Navigate to the directory with the relevant files using one or more of the following Options:
 - a. Select a drive.
 - b. Use the path navigation buttons (Root Directory, One Level Up).
 - c. Use the Search function
3. Once in the correct directory, start selecting one or more folders or files by tapping the **Check Boxes**.
4. Observe that the **Location Icon** in the opposite split window changes to the **Destination Icon**. As soon as you start a collection by checking the first item, the active directory of the opposite split window is set as destination by default. You can change this any time by navigating to a different directory and tapping the **Location Icon**. Consequently, the **Location Icon** changes to the **Destination Icon**.
5. Continue gathering folders and files by repeating steps 1-3.
6. Compile a second collection (optional) by activating the opposite split window (tap the area of folder contents) and proceed in the same fashion as described in steps 1-5. Note, that selected files of collection 1 appear grayed out. A file or folder can't be member of 2 collections at the same time. Navigate back in collection 1 and uncheck the item first before adding it to collection 2 and vice versa.
7. Activate a split window with an active collection, check the correct destination in the opposite window and tap the button for the chosen task.
8. (Optional) Repeat step 7 for existing collections of the opposite split window.

13.3.6 SELECTION RULES AND METHODS

The design of the gathering process requires unique rules of selection to avoid logical conflicts.

13.3.6.1 PARENTING

The G9 file manager uses the concept of **parenting**, which applies to selecting folders of a hierarchy. When checking a folder (Parent), all contained files and folders (Children) are checked likewise. If you check a parent and open the folder afterwards to uncheck files and folders to be excluded from the collection, the parent will remain checked. All its children stay checked, except for those who were unchecked manually. To facilitate this process the **[Check All]** and **[Uncheck All]** buttons are available. Both buttons follow the concept of parenting as well.

13.3.6.2 MEMBERSHIP OF A COLLECTION

Within the concept of collections, **no file or folder can be member of more than one collection**. Without this rule, a file in collection 1 could be moved to a different destination in first place. If it was member of collection 2 as well, the job protocol would address a dead path by the time of processing the job task of collection 2.

To avoid this conflict, the File Manager does not allow for double checking files and folders. Items checked in the left split window (Collection 1) will appear checked and grayed out in the right split window (Collection 2) and vice versa. Selections are only editable in the split window of the collection they are member of. Consequently, moving a file or folder to another collection requires unchecking it in Collection 1 first, to make available for Collection 2 (and vice versa).

13.3.6.3 REFRESH VS. UNCHECK ALL

The **[Uncheck All]** button affects all files and folders in the active directory and all files and folders in the **hierarchy below**, whereas **[Refresh]** unchecks **all members of the collection** of the active split window. With the search dialogue active **[Refresh]** only affects the search term. Deleting a collection is only possible in the default File Manager Screen.





Refresh



Uncheck All

13.3.7 COLLECTION BASED TASKS -MOVE/COPY/DELETE

With all collections compiled and destinations set, you can start the job task, by tapping one of the task buttons. Not every button behaves the same. The following list gives insight in the idea of each task:

Collection Based Tasks (Batch Processing)	
	Move
	Copy
	Delete

- **Move**
 - Collection based, affects all members of the collection in the active split window.
 - System calculates free disc space (SD, USB) before and after transfer, executes the job or returns an error message.
- **Copy**
 - Collection based, affects all members of the collection in the active split window.
 - System calculates free disc space (SD, USB) before and after transfer, executes the job or returns error message.

- **Delete**
 - Collection based, affects all members of the collection in the active split window.
 - Always asks for permission before executing the job.

Delete will trigger a warning message, allowing to change your mind and cancel the operation. **Undo** and **Redo** functions are NOT available in conjunction with **Move**, **Copy** and **Delete**.

13.3.8 ORGANIZE – NEW FOLDER AND RENAME

In the previous sections we discussed the concept of collections whose members are selected by using **check boxes** next to every list entry. Along with this concept we have presented three functions which can handle multiple selections at the same time, and which were consequently called "collection-based". These features are: Move, Copy and Delete.

There are more functions in the Task bar which work independently from existing collections: **Rename** and **New Folder**.

13.3.8.1 NEW FOLDER

New folders can always be added, even during the process of compiling collections for batch processing. Existing collections will remain intact when creating folders "on the fly".

Tapping the icon **[New Folder]** in the task bar will create a folder in the visible directory of the active split window. If necessary, please activate the split window of your choice beforehand by a single tap inside its frame.

Creating new folders:

1. (Optional) Select a split window by a single tap.
2. (Optional) Navigate to a directory of choice.
3. Tap **[New Folder]** in the **Task Bar**.
4. Enter a name using the keyboard.
5. Confirm by tapping **[OK]** or abort by tapping **[Cancel]**.

13.3.8.2 RENAME

As with creating new folders, renaming of single list entries is always possible, without destroying existing collections. You can even rename already selected entries without losing collection memberships, if you perform the action in the window where they were selected.

As opposed to collection-based functions, renaming makes use of highlighting list entries. Tapping on a list entry outside the check boxes will highlight it by adding a thick bar in the background.

Note that the File Manager does not provide collection-based batch rename. This method would give every file and folder the same name followed by a number. After this procedure all information to identify a file would be lost. This feature only makes sense when dealing with photos, where you still have a thumbnail to identify the image. The G9 is a pro audio device and priorities in functionality are set accordingly.

Rename a file or folder as follows:

1. Highlight the File/Folder in the file list by a single tap. Avoid touching its check box.
2. Tap **[Rename]** in the Task Bar.
3. Enter a new name using the keyboard.
4. Confirm by tapping **[OK]** or abort by tapping **[Cancel]**.

13.3.9 HISTORY – UNDO AND REDO

The G9 File Manager features a 10-step history recording the following actions:

- a. Directory nodes visited across all storage mediums (SD, USB)
- b. Selections

This means that it tracks all actions across both split windows. Use the **[Undo]** and **[Redo]** buttons to move back and forth in history.



13.3.10 CLOSING THE APP

The File Manager closes by changing the mode or switching to one of the Apps inside the **Tools** modes. Existing Collections are retained until the G9 is shut down.

13.4 UTILITIES

The functions presented in this section find their application mainly in the Tools mode.

13.4.1 SEARCH

 The search function of the G9 is viewed as a plug-in which is not exclusive of the File Manager. It can appear in other file browsers as well. It is designed as an inline tool which can be utilized as an alternative to linear path navigation (open folders by double tapping) and therefore inherits all important functions from the **File Manager Task Bar**.







13.4.1.1 PROPERTIES

- Keyboard at the bottom
- Search box
- Visible, active path (updates real time)
- Buttons for source selection (Internal, external)
- Buttons for navigation (Root Directory, One Level Up)
- Buttons for selections (Check All, Uncheck All – File Manager only)
- Refresh button to delete search term/string)
- List of results with scroll bar for longer lists
- Check boxes for selection (File Manager)



13.4.1.2 CONCEPTION

In File Manager, the search function serves as an In-line feature when compiling collections (see 13.3.5 *Compiling Collections on page 150*). Meaning, that it can be utilized at any time and alternatively to linear folder navigation. Consequently, the search dialogue inherits all relevant icons of the task bar needed to serve this purpose. **Note, that in the search dialogue, the refresh button changes its function to clearing the search term only** (compiled collections remain intact)! Clearing collections can only be realized outside the search dialogue.

Search	
	Refresh (clears search term from the search box)
	Internal SD card (opens root directory)
	External USB device (opens root directory)
	Go to root directory of active path in active split window
	Move up one level in folder hierarchy
	Check All
	Uncheck All

- Opens by tapping the magnifying glass in the UI.
- Affects the active browser/split window only.
- Enter a search term via the keyboard.
- **Search rule:** "contains one or more words of the search term"
- Searches in the active folder and the hierarchy below.
- Lists files and folders.
- Navigation **up the path** (Buttons: Root Directory, one Level up)

- Navigate **down the path** by double tapping a folder.
- Double tapping does not select files/folders.
- Double tapping opens folder – Auto deletes search term (auto refresh) to view folder contents and edit selections caused by parenting.
- Double tapping files → no selection, just highlight
- List with results obeys filter and ordering settings.
- Selection via the check boxes
- Multiple selections possible
- "Check All" selects the complete result list only.
- "Uncheck All" only applies to list of results.

- **File Manager**
 - List with results obeys filter and ordering settings made in the **Filter Manager**
 - Selections are added to collections of the active split window.

- **File Browsers (Song Player, PDF Reader etc.)**
 - No selection via check boxes – just regular browsing functionality
 - Independent from Filter Manager

- **Refreshing, editing the search term**
 - Selections made so far (Check Boxes) are added to the collection (File Manager) → continues collecting items for collections.

- **Close**
 - Tap "Close"
 - Or (Song Player/PDF Reader) → Double tap a file to select
 - Or change mode (e.g. to Performance)

- **Close Rules**
 - Selections made so far (Check Boxes) are added to the collection (File Manager).
 - Discards last search term.
 - Everything else: no effect (forgets having opened the search dialogue)

13.4.2 FILTER MANAGER



The Filter Manager is also viewed as a plug-In. It's application is primarily in conjunction with the File Manager. With longer lists of allowed file types, it is not possible to position all filters and ordering rules in the main screen. Consequently, sorting functions and filter types are organized in the filter manager menu. Filters and sorting rules can be activated or deactivated globally in the **Task Bar**.

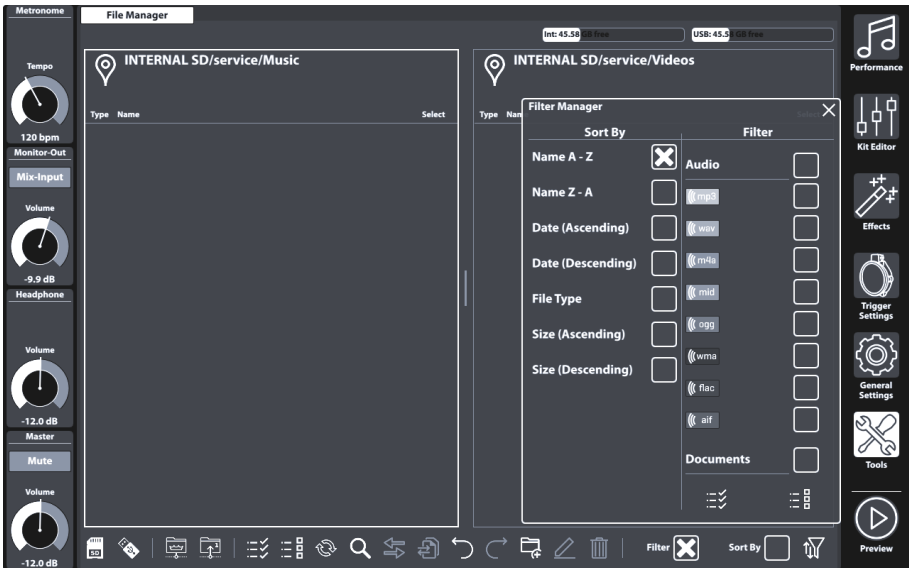









13.4.2.1 PROPERTIES

Each file browser of the G9 provides filtering and ordering options which operate independently from each other. Consequently, the **Filter Manager** only affects browsers, where it is available.























































- Opens by tapping the Filter Manager button
- Filters and ordering rules can be globally activated or deactivated in the task bar (Check Boxes)
- Columns with scroll bars
- Filter section categorized by file types
 - Multiple selections possible
 - Checking a category will select all file types of that category at the same time (parenting).
 - Uncheck individually if needed (category check box becomes unchecked, other children remain checked).
 - Check All/ Uncheck All buttons available (affect all categories and their file types at the same time)
- Sorting Function
 - No multiple selections allowed
 - Choose one of the options provided.
- Close
 - Close the dialogue by tapping the filter manager icon.
 - Change the mode (e.g. to Performance).
 - Tap a cross in the upper right corner of the manager.
 - Tap in any other area of the File Manager interface.
- Closing rules
 - Stores the last state of the Filter Manager (Selections) automatically.

13.4.2.2 FILTERS AND SORTING OPTIONS

The following table shows the complete list of sorting options and categorized Filters available. The G9 Filter Manager orders file categories by relevance to minimize the need of scrolling down the list during your daily work. Selections made in the Filter Manager will not affect **File Select** browsers (Song Player or PDF Reader), but only apply to the split windows of the **File Manager**.

Filter Manager			
Sort By		Filter	
Name A-Z	<input checked="" type="checkbox"/>	Audio	<input type="checkbox"/>
Name Z-A	<input type="checkbox"/>	 mp3	<input checked="" type="checkbox"/>
Date (Ascending)	<input type="checkbox"/>	 wav	<input type="checkbox"/>
Date (Descending)	<input type="checkbox"/>	 m4a	<input checked="" type="checkbox"/>
File Type	<input type="checkbox"/>	 mid	<input type="checkbox"/>
Size (Ascending)	<input type="checkbox"/>	 ogg	<input type="checkbox"/>
Size (Descending)	<input type="checkbox"/>	 wma	<input type="checkbox"/>
		 flac	<input checked="" type="checkbox"/>
		 aif	<input type="checkbox"/>
		Documents	<input checked="" type="checkbox"/>
		 PDF	<input checked="" type="checkbox"/>
	
		⌵	⌵
		⌵	⌵
		⌵	⌵

Filter Manager – Complete Filter List

Audio	Docs	Playlists	Video	Drum Kits	Device Specific	Music Notation	Graphics	Web
								
								
								
								
								
								
								
								
								
								
								
								
								

13.5 IMPORT TOOL



With the import tool it is possible to import files which are meant to be accessible in the sound library. Apart from the copy process, these files need to be encrypted into a G9 native format. If you just want to transfer files to the internal drive, please use the **File Manager**. The import tool addresses the reserved partition for user samples on the built in 4 GB flash memory.

The required file format for the import of custom sounds is **wave**. Only **single layer** Stereo files up to a maximum size of 32 MB can be imported, whereas the **Shop** offers a selection of **multi-layer** samples.



On Stage



PDF Reader



Import Tool



Shop



File Manager











Tools

13.5.1 IMPORTER

The Importer handles both ways of sound import. It lists all sounds in the order they were imported giving them a unique index number or import slot. The **Library** column lists all imported sounds. These sounds are available in the **Sound Browser**, filed under a specific instrument category and indexed according to the next free slot number available. The **Trash Can** icon deletes an entry from library and Importer likewise.

The **Storage** column lists all downloaded sound packages from the **Cloud**. Downloaded sounds are provided as **Sound Packages** with several containers which represent the different Instrument categories of the **Sound Browser**. It is not mandatory to import a complete drum kit or sound package. The storage column allows for importing individual containers only and gives an overview of which containers are imported from which sound package. Imported containers are highlighted (collapsed package view) or preceded by their import index (expanded view). Containers preceded by an arrow are downloaded, but still not imported.

The **Importer** serves as the management tool for all your imported sounds.

Importer		
Library	Storage	
1 Imported Container B Sample Bow Sample Edge Sample Bell		Sound Package 1 (Collapsed)  Container A Container B (imported) Container C
101 Imported Custom WAV 1		Sound Package 2 (Expanded)  2 Container 1 (imported) < Container 2 (not imported) < Container 3 (not imported)
2 Imported Container 1 Instrument 1 Instrument 2 Instrument 3		
102 Imported Custom WAV 2		
103 Imported Custom WAV 3		
Memory Usage: 23% Status: 10%		

13.5.2 IMPORT CUSTOM SAMPLES (SINGLE LAYER)

To import your custom samples, proceed as follows:

1. Go to **Tools** ➔ **Import Tool**
2. Tap [**Import wav samples**] to open the **File Select** browser.
3. Select a source (USB or internal SD card).
4. Browse to your directory with the desired samples.
5. Select a sample file by double tapping.
6. Observe the **Library** column until the import is completed (a **trash can** appears next to the imported file).
7. Go to **Kit Editor** ➔ **Module 2** ➔ **Sound Select** and assign imported sounds via the **Sound Browser**.



The File Select browser is explained in detail in **Performance** mode (see section 8.3.1.1 File Select Browser on Page 28).

G9 File Select Browser - Source Selection and Search



Navigation – Up the path



G9 File Select Browser (WAV)

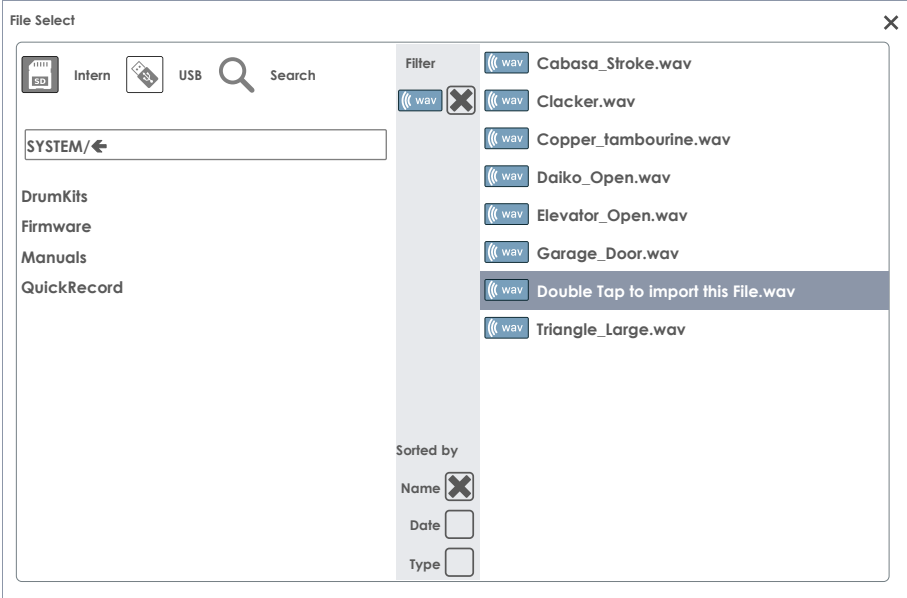

The **Sound Browser** is explained in detail in the **Kit Editor** section. Imported custom sounds are filed under category tab “**Wave**”. Select **Import as Source** (see section 9.2.1.4 *Sound Browser – Properties on page 41*).

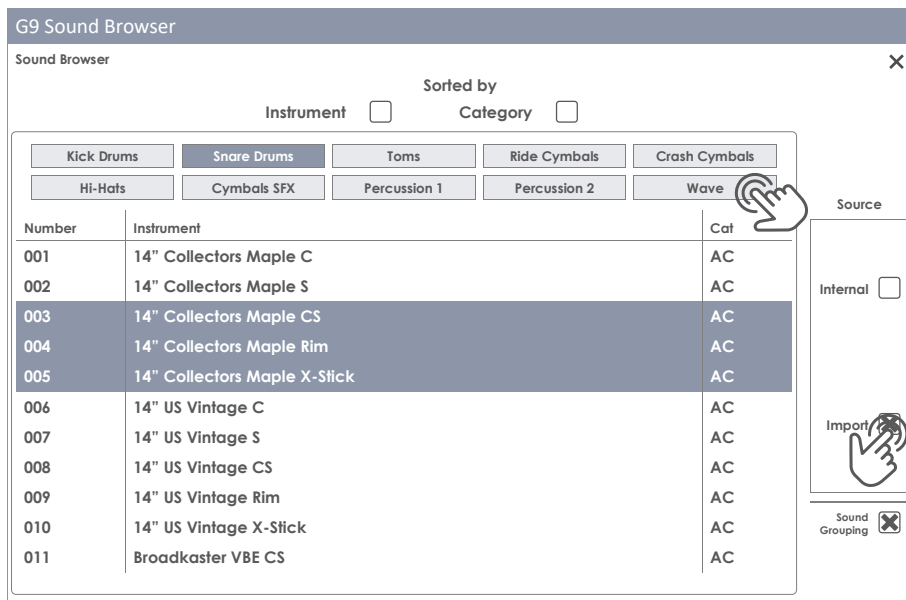

13.5.3 IMPORT SOUNDS FROM THE CLOUD

Sounds purchased in the Sound Store will appear in the **Storage** column after they have been downloaded to your local device using the G9 Shop application (see section 13.6.1 *Connecting to the Cloud on page 164*). The import process is identical with the import of custom sounds. However, sounds are downloaded and displayed as containers by instrument category in the storage tab. Complete drum kits require each container to be imported individually. This allows the user to extract individual instruments from a complete drum kit, cymbal set or instrument package.

To import a sound container, proceed as follows:

1. Expand the downloaded sound package by tapping the **[+]** button.
2. Tap once on the containers to be imported.
3. Observe the **Library** column until the import is completed (a **trash can** appears next to the imported file).
4. (Optional) Repeat steps 1 and 2 for other containers in the **Storage** tab.
5. Go to **Kit Editor** → **Module 2** → **Sound Select** and assign imported sounds via the **Sound Browser**.

The **Sound Browser** is explained in detail in the **Kit Editor** section. Imported sounds from the cloud are automatically filed under the instrument categories associated with the imported containers. Select **Internal** as **Source** (see section 9.2.1.4 *Sound Browser – Properties on page 41*).

13.5.4 DELETE SOUNDS FROM THE LIBRARY

1. Go to **Tools** → **Import Tool**
2. Locate the sounds to be removed in the **Library** column.
3. Tap the **Trash Can** icon.

Deletion of imported Sounds removes the **Library** entry of the **Import Tool** as well as its entry in the **Sound Browser**.

13.5.5 IMPORT LIMITS AND SOUND MANAGEMENT

Both, **Wave file import** and import of sounds from the **Shop** address the built-in 4 GB flash memory. This way you have quick access to your sounds while playing, resulting in fast loading times for drum kits using the **Drum Kit Selector** or the **On Stage** tool. Although in most cases the storage space available is sufficient, so called "power users" might experience the limitations implemented, which will prompt the question of how to deal with these limitations. This section will provide some guidelines efficiently organize your sounds.

13.5.5.1 FACTS

The internal 4 GB Flash memory is divided in two parts: One half hosts the **factory sound bank**, which cannot be modified or deleted by the user. The other half (2 GB) is freely manageable.

Regarding limits, there are 2 types to be aware of: Maximum number of **import slots** and **maximum storage space** available for sound import. Additional limitations exist for the properties of the WAV file format (see section 16 *Technical Data on page 170*).

Sound Import - Limitations

Import Slots	Storage usage
100 Slots for WAV import (101-200)	2 GB Flash memory available for user import (2 GB are reserved and occupied by the factory sound bank)
100 Slots for Shop import (1-100)	

13.5.5.2 SCENARIOS FOR IMPORT LIMITATIONS

It is easy to reach the maximum number of import slots by importing numerous small WAV files. Over time, these imports will accumulate and since they are small, chances are high that you finally reach upload slot 200 while consuming only a small amount of flash memory.

Reaching the maximum memory size by exclusively using the WAV import would mean that you consistently import recordings close to the **maximum recording time** of three minutes, which is equivalent to a file size of approximately 32 MB. The application of such samples in the drumming context is very scarce, so that regarding the WAV import, you are most likely to be confronted with an **upload slot limit**.

In case of **Shop** sounds the situation is different. These sounds are multi-layered and thus, much larger in size than their single-layered WAV counterparts. Consequently, memory space available plays a more important role. Especially Hi-Hat sound packages, which cannot be split into components, must additionally include sounds for different opening positions of the Controller/Pedal. Next to the dimensions of MIDI Velocity Layers and Number of different Samples per Layer, another dimension is added. Consequently, with a regular 300 MB Hi-Hat package one will use up maximally 7-10 import slots until the device will return a warning message regarding the **maximum storage usage**.

13.5.5.3 REACTING TO IMPORT LIMITS

The answer is simple: Delete unused sounds from the sound library and don't be afraid to do so! Deleting a sound from the library will generate free space on the internal flash memory. This is realized by tapping the trash can icon in the **Importer** (See section 13.5.1 *Importer on page 158*). While the technical side is easy to solve, concerns about the loss of data might follow and need to be addressed. In the following we will provide a few tips to dispel doubts.

13.5.5.4 DATA LOSS

By removing sounds from the library using the **Import Tool**, entries are removed and deleted from the flash memory, but they are still accessible for reimport on the internal SD card or a USB device. Acquired sounds from the **Shop** are downloaded on the internal SD Card prior to the import. This part of the SD Card is hidden and not accessible using the **File Manager**. Downloads from the **Shop** are listed in the **Storage** column of the **Importer** and moreover, are only accessible inside the **Import Tool**. After deletion from the **Import** column, **Shop** sounds remain listed in the **Storage** column are ready for reimport - parked on the SD Card. An exception is the **Factory Reset**. As opposed to the data accessible via **File Manager**, a factory reset will delete shop downloads from SD and empty the **Storage** column of the **Importer**. In this case you must carry out an additional step and download the sounds from the **Shop** again. The embodiment of property rights of sounds excludes the repurchase of sounds deleted from the device. This means, that they are always available for Download after the login to the **Shop** application (see section 13.6.3 *Digital Property Rights on page 165*).

Regarding the import of WAV samples, we recommend creating an "import" folder on the internal SD Card using the **File Manager** and copy your sounds to the device before any import. This way you have your sounds always available for import. Such files remain untouched by the **Factory Reset**.

13.6 SHOP



The shop tool provides direct access to the **GEWA Cloud**, where you can download additional sounds and samples purchased online in the **Sound Store**. Items purchased will be unblocked and from then on are listed for download in **Tools** → **Shop** and filed under the sample categories they belong to (Drumkit, Artist Kit, Percussion etc.).



Before you can access the shop, you need to:

- Register your product online so that your G9 can decrypt the downloaded files.
- [\[paste store/shop/cloud link here\]](#)
- Establish a Wi-Fi connection with an available network.

For information about the registration process please refer to [\[store website\]](#). How to connect to your local network is explained in section 12.4.2 *Wi-Fi on page 128*.

Once registered and connected via Wi-Fi, you are ready to communicate with the Cloud. Note that the G9 Shop application enables you to only download your purchased sounds. To make them available in your local sound library, sounds must be imported in a second step, utilizing the G9 **Import tool** (see 13.5 *Import Tool on page 158*).

13.6.1 CONNECTING TO THE CLOUD

1. Go to **Tools** → **Shop** to open the Cloud browser.

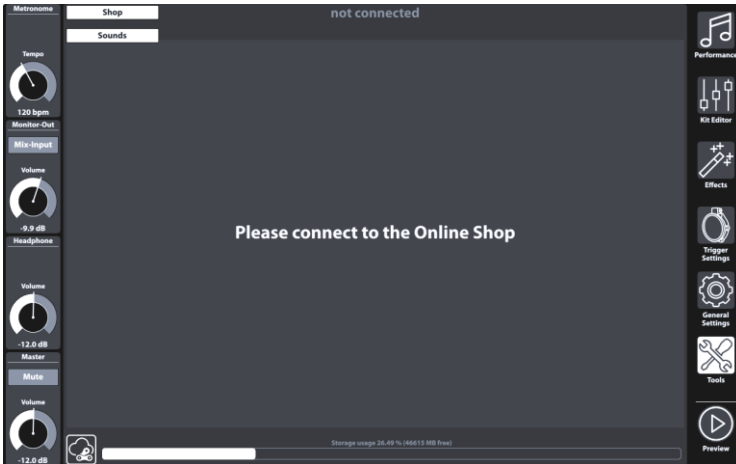

On start-up you are disconnected from the cloud by default and the landing page of the shop browser asks you to connect you G9 to the Cloud.

2. Tap on the **[Status]** button in the bottom left corner of the shop screen.

Icons - Cloud



Status button (Tap for connection details)

This will call up the **Login** pop-up. The dialogue contains information about your login data, such as **Serial Number** and the **Username** chosen during your registration. Highlighted in red you can observe the current status of your cloud connection, which should be **not connected**.

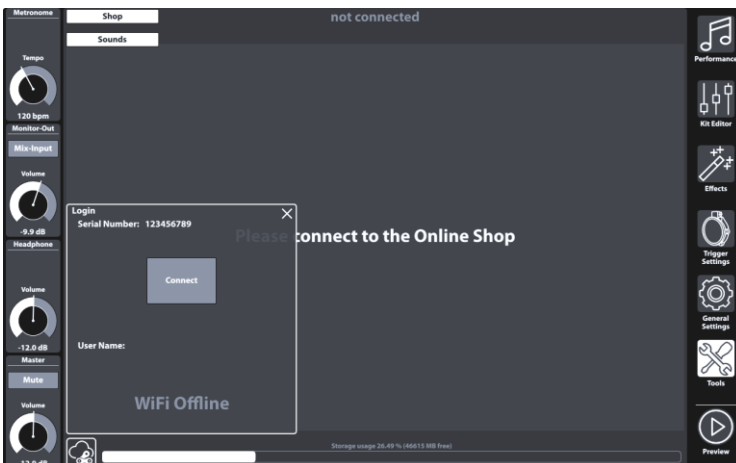

3. Tab **[Connect]** which should change the status to "connected" (highlighted in green).

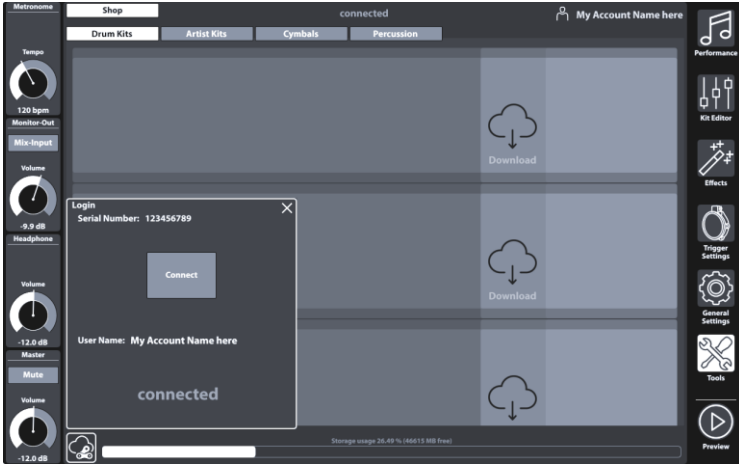

4. Close the Login dialogue by tapping **[X]**.
The Pop-up closes, and you should see your purchased items listed in the Sounds tab.
5. Browse the sounds sub tabs to view your purchased sounds by category.
6. Tap **[Download]** for sounds you want to import into the sound library and proceed with the import process. (see 13.5 *Import Tool on page 158*).

13.6.2 BILLING PROCESS

When browsing sounds online in the GEWA sound store you will find a **[buy]** button next to each item. Follow the wizard, choose your payment method and conclude your purchase. Confirmation email and invoice will be sent to the email address specified during the registration.

13.6.3 DIGITAL PROPERTY RIGHTS

With the purchase of a sound via the GEWA sound store the customer acquires a lifetime license, which entitles to download, and import purchased sounds for an infinite amount of times on up to 5 (five) G9 devices parallelly. The digital rights acquired apply to the number of registered device serial numbers in the sound store which are exchangeable.

13.6.4 SALE OR EXCHANGE OF A G9 DEVICE

Herewith, the customer is informed, that by selling a G9 device, existing digital rights will not expire and are still held by the seller. The buyer will have access to the sounds as long as the serial number of the sold device remains listed in the GEWA sound store account of the seller. It is the seller's responsibility to remove the serial number of the sold device from his GEWA sound store account before the sale. Without removal of serial numbers, buyers can use the sounds bought by the seller and are not able to conclude purchases themselves if the serial number of the bought apparatus relates to the sellers account.

14 USEFUL INFORMATION

14.1 EXPLANATION OF TERMS

Term	Definition
MIDI	<p>Musical Instrument Digital Interface is a data transfer protocol. With this, musical control information is transferred between electronic instruments such as digital pianos, keyboards, synthesizers, drum computers or even PCs or laptops. To exchange this control information, the instruments/computers require MIDI connections and a link must be established between them. There are different MIDI connections with various functions: MIDI-IN (input), MIDI-OUT (output) and MIDI-THRU. The last one routes received data untouched from MIDI to be used for another MIDI device.</p> <p>Here is an example: If a key on the digital piano is pressed, digital data packets are sent from MIDI IN to MIDI OUT (MIDI-OUT). The data packets contain information on pitch, keyboard dynamic and the duration of the keystroke. The data packets output can be e.g. recorded, stored, played back on the computer and also displayed as notation on the screen if the application is able to do this. Recorded MIDI data can then be sent to a MIDI instrument, e.g. a digital piano, to make it audible again.</p>
GM	<p>General MIDI defines a lot more than what is defined in the basic MIDI protocol. It combines hardware and protocol specifications. General MIDI also specifies content. For this, GM sets a minimum standard for the assignment of the instruments to 128 program places. According to GM, a compatible GM MIDI instrument must be able to generate 24 sounds simultaneously. Furthermore, according to GM, additional control parameters are defined, such as e.g. effect control.</p>
General MIDI standard sounds	<p>Sounds or instruments in compliance with the specifications of the General MIDI standard protocol.</p>
Reverb	<p>This simulates a room environment. It is preconfigured for some sounds to give them a more lively and realistic appeal.</p>
Chorus	<p>The chorus effect adds another slightly detuned note to every note that is played. This produces a fuller ensemble like impression.</p>
Samples	<p>Samples are audio clip recordings from natural instruments. All sounds of sampled instruments are recorded and saved to logically defined locations. This then leads to an organized sum of sampled single notes, which, when played back, sound like the originally sampled natural instrument.</p>
DSP	<p>A digital signal processor (DSP) is a chip which is responsible for a continuous processing of digital signals such as audio and video signals.</p>
Polyphony	<p>Maximum number of simultaneously playable notes. A high number of simultaneously playable notes ensure a highly natural sound impression.</p>
Piezo	<p>Short term for piezo ceramic element (aka Buzzer). When deforming a piezo, a low electric voltage is generated, which depends on the degree of deformation. These sensors are used to detect the "velocity" or impact of a stroke in electronic drums and cymbals.</p>
FSR	<p>Force Sensitive Resistor are sensors used in cymbals to detect Choke, Crash (Edge) and Bell Signals. Unlike a piezo ceramic element, which produces electrical voltage when being deformed, FSR films always carry a low voltage which decreases by applying pressure to the film (decreasing resistance).</p>

14.2 WARRANTY

Warranty for a period of 2 years from the date of purchase on hardware and workmanship is granted by the dealership where the digital drum set or console was originally bought. In the event of a proven defect, the buyer has in the first instance only the right to receive supplementary performance. Supplementary performance includes either rectification or supply of a replacement product. Equipment or exchanged parts become to be the property of the processing dealership.

In the event supplementary performance should fail, the buyer may negotiate a reduction of the purchase price or withdraw from the contract and, if the dealership is responsible for the defect, demand compensation for damages and/or expenses deriving from the defect(s). The buyer must inform the dealer immediately on any defects identified. The only way to prove a warranty claim is that the buyer can present a valid proof of purchase, e.g. invoice.

Damage arising from incorrect handling, operation or storage as well as by force majeure or other external influences, does not comply with the warranty terms, nor in addition does the use of consumer products such as e.g. rechargeable batteries, strings, skins or seals. If you suspect to have a claim covered by the warranty terms regarding your GEWA digital Drum Console, please contact your dealer during regular business hours.

15 TROUBLESHOOTING AND POSSIBLE SOLUTIONS

Problem	Possible Solutions	
The console does not boot when pressing the power button.	1	Make sure the power cord is connected correctly to electrical outlet and apparatus. Live installations will cause power button to light up. (stand-by → red, on → white)
The user interface freezes (no reaction to finger gestures).	1	Perform a hard reset by holding down the power button until the device shuts down. Try to restart by tapping the power button again. (If this happens in a dry environment and in absence of any climatic extremes, please contact the customer service.)
I can hear only one pad component (e.g. Head OR Rim).	1	Make sure that the stereo cables connecting pad and console are plugged in completely. Regarding GEWA cymbals and modules, the stereo cable needs to be connected to the socket facing the cymbal piezo.
I can't hear any sound (Neither the Drum Kit nor any other sounds such as playing songs or metronome).	1	Check whether your headphones or speakers are connected to the console correctly.
	2	Make sure your output volume dials are not muted (Headphone, Master, Mix Input).
	3	Check settings in the routing matrix and load one of the "Factory Presets". General Settings → Module 1 → Routing Drums and Routing others
I can't hear any sound of connected pads, but trigger monitors respond to playing them. Song Player and Metronome however are both audible.	1	Check settings in the routing matrix and load one of the "Factory Presets". General Settings → Module 1 → Routing Drums and Routing others
	2	If you have worked with MIDI lately, a turned off Local Control might prevent the control data generated by the connected hardware from accessing the internal sound engine. Check General Settings → Module 3 → MIDI → Global MIDI Settings (Soft Thru) → Local Control .
The Mix Input or Monitor-Out Volume is not adjustable.	1	It is. By default, the corresponding dial is set to Monitor-Out. Tap the grey button below the dial name to switch between Monitor Out and Mix Input and try again. (Dial panel on the left-hand side of the touch screen)
I can't hear any metronome sound, but I can hear the drum kit and playing songs.	1	The Metronome is likely to be muted in Visual Mode. Check Performance → Module 4 (Metronome) → Visual Mode .
	2	The Metronome is not routed to the output you are listening to. Check "Click" in General Settings → Module 1 → Routing Others .
Component icons in Kit editor don't match the connected pad type.	1	Assign a matching trigger bank to the input channel in question and save a new trigger setup. Icons shown in Kit Editor are driven by the trigger bank assigned to an input channel. (Triggers Settings → Module 1 + 2)
I have Imported sounds using the import tool, but I cannot find them in the sound browser (Kit Editor).	1	Open the sound browser and check "Import" under source on the right-hand side of the browser window. This will list only imported sounds. Like the factory sounds, the imported sounds are filed under the matching instrument category. Browse the tabs.

16 TECHNICAL DATA

G9 Drum Workstation – Technical Data	
Drum-Kits	40 Preset + unlimited User Presets
Instruments	more than 400
Effect Types	Pad Compressor & 3-band full parametric EQ per Pad Output Compressor & 4 Band full parametric EQ per Output Room Reverb & Instrument Reverb: 12 Types / Multi Effects: 9 Algorithms
User Sample Import	100 Wave and 100 Multi layered full instruments (Head/Rim/X-Stick - Bell/Bow/Edge) File Format: WAV (only PCM format) [44.1kHz/48kHz, 16/24/32 bit, up to 8M samples per channel [≈3 min Stereo]] Mono or stereo channels
Storage	USB/internal Memory
Recorder	Realtime (wav) File Format: WAV (44.1 kHz, 16 Bit)
Display	1280 x 800px TFT integrated in Touch Display 4 Hardware Dials, Software based
External Memory	external USB
Connections	TRIGGER INPUTS: 14 x ¼" TRS Socket MONITOR OUT: 2 x ¼" TS Socket (Mono) MASTER OUT: BALANCED XLR SPDIF (Stereo) 48 kHz DIRECT OUT: 8 x ¼" TS Socket (Mono) PHONES: ¼" TRS Socket (Stereo) MIX IN: ¼" TRS Socket (Stereo) MIDI (IN, OUT/THRU)-Outputs COMPUTER-CONNECTION: USB B-Type (USB Hi-Speed AUDIO/MIDI) FOOT SWITCH: 1 x ¼" TRS (2 Channel) AC IN (IEC C17)
Wireless Connections	Bluetooth, Wi-Fi
Recording	Sampling Rate (Original): 48 kHz Sampling Rate: (with Converter): 96 kHz, 44,1 kHz Recording: 8 Channels Play: 2 Channels
Power Supply	AC 100V-240V 50Hz - 60Hz
Electricity Consumption	10 W (IEC 62087), 55 W (EN60065)
Dimensions	340 (W) x 215 (D) x 91 (H)
Weight	3,3 kg
Accessories Included	Multilingual Quick Start with Safety Regulations, (Print) USB Dongle with Multilingual Quick Start Guide. 5 Mains Cords (Type A, Type C (CEE 7/17 and CEE 7/16), Type F, Type I)
* All specifications and appearances are subject to change without notice	